



garant.de

Weil ich weiß, was mir gefällt
Because I know what I like

Zeitlose Weißlacktüren für moderne Raumgestaltung
Timeless white varnish doors for modern interior design concepts



Themen

Themes

Seite 04–05 DieTÜR – Digitales Türentool | DieTÜR – Outil numérique pour les portes

Seite 06–15 **NORMTÜREN-PROGRAMM | STANDARD DOOR RANGE**

Seite 08–13 NORMTÜREN | STANDARD doors

Seite 14–15 Gesamtübersicht NORMTÜREN | Overview of all STANDARD DOORS

Seite 16–25 **DESIGNTÜREN-PROGRAMM | DESIGN DOOR RANGE**

Seite 18–23 AURA | AURA

Seite 24–25 Gesamtübersicht DESIGNTÜREN | Overview of all DESIGN DOORS

Seite 26–53 **PROFILTÜREN-PROGRAMM | PROFILE DOOR RANGE**

Seite 28–33 MILANO | MILANO

Seite 34–39 RIVA | RIVA

Seite 40–45 COMO | COMO

Seite 46–51 PARMA | PARMA

Seite 52–53 Gesamtübersicht PROFILTÜREN | Overview of all PROFILE DOORS

Seite 54–63 **STILTÜREN-PROGRAMM | STYLISTIC DOOR RANGE**

Seite 56–61 AMRUM | AMRUM

Seite 62–63 Gesamtübersicht STILTÜREN | Overview of all STYLISTIC DOORS

Seite 64–75 Elemente | Elements

Seite 76–95 **TECHNISCHE DETAILS | TECHNICAL DETAILS**

Seite 78–85 Glas-Übersicht | Glass overview

Seite 86–101 Beschläge | Fittings

Seite 102–105 Zargenausführungen, Bänder | Frame types, hinges

Seite 106–107 Weißlack-Eigenschaften | White varnishproperties

Seite 108–109 Weißlack mit Funktion | Functional white varnish

Seite 110–111 Maße | Dimensions

Seite 112–115 Gesamtübersicht | General overview

Uneingeschränkt umweltverträglich

Totally eco-friendly

Makellose Lackierungen sind einfach faszinierend. Mit hochwertigen, umweltschonenden UV-gehärteten Acryllacken, modernen Walz- und Spritzverfahren und permanenter Qualitätskontrolle sorgen wir dafür, dass unsere Türen auch auf Jahre hinaus nichts von ihrer Faszination verlieren. So sind unsere seidenmatten Weißlacktüren überall dort zu Hause, wo klassisches Türdesign und zeitgemäßer Pflegekomfort gefragt sind.

Gut zu wissen: Jede GARANT-Tür wird in unserem Werk in Thüringen hergestellt, wo moderne, computergesteuerte Maschinen für höchste Präzision und Qualität sorgen. Erst die handwerkliche Arbeit und das geschulte Auge erfahrener Mitarbeiter geben ihr jedoch den letzten Schliff.

Perfect varnish finishes are simply fascinating. We use high-quality, eco-friendly UV-hardened acrylic varnish, modern roller coating and spray methods and continuous quality controls to ensure that our doors retain their fascinating qualities over the years. Our silk matte and white varnish doors are perfect for all home design scenarios requiring classic or contemporary low-maintenance doors.

Good to know: Every GARANT door is manufactured at our factory in Thuringia using computer-aided machines for maximum precision and quality. However, we depend on the skilled eyes of our experienced craftsmen to add the finishing touches.



DieTÜR – Digitales Türentool

Über 1 Millionen Kombinationen für Ihre Wunschtür

BEQUEM WUNSCHTÜR KONFIGURIEREN

In einer Türenaussstellung ist nur für eine bestimmte Anzahl an Modellen Platz. Nicht alle Varianten einer Tür können gezeigt werden. Um diese Lücke zu schließen, haben wir das Online-Tool „DieTÜR“ entwickelt. Hierüber haben Sie und Ihre Kunden Zugriff auf über 1 Millionen Kombinationen einer Tür – und mit jedem Update werden es mehr. Ein Highlight bietet die Funktion „Tür im Raum darstellen“. So kann sich der Kunde seine Wunschtür besser in seinem Haus vorstellen.

Außerdem kann er seine Wunschliste samt QR-Code ausdrucken und damit zu Ihnen in den Fachhandel gehen. Vor Ort scannen Sie einfach den QR-Code und wissen sofort, was der Kunde möchte.

QR-CODE AUF DEN FOLGSEITEN SCANNEN UND EINFACH SELBST KOMBINIEREN

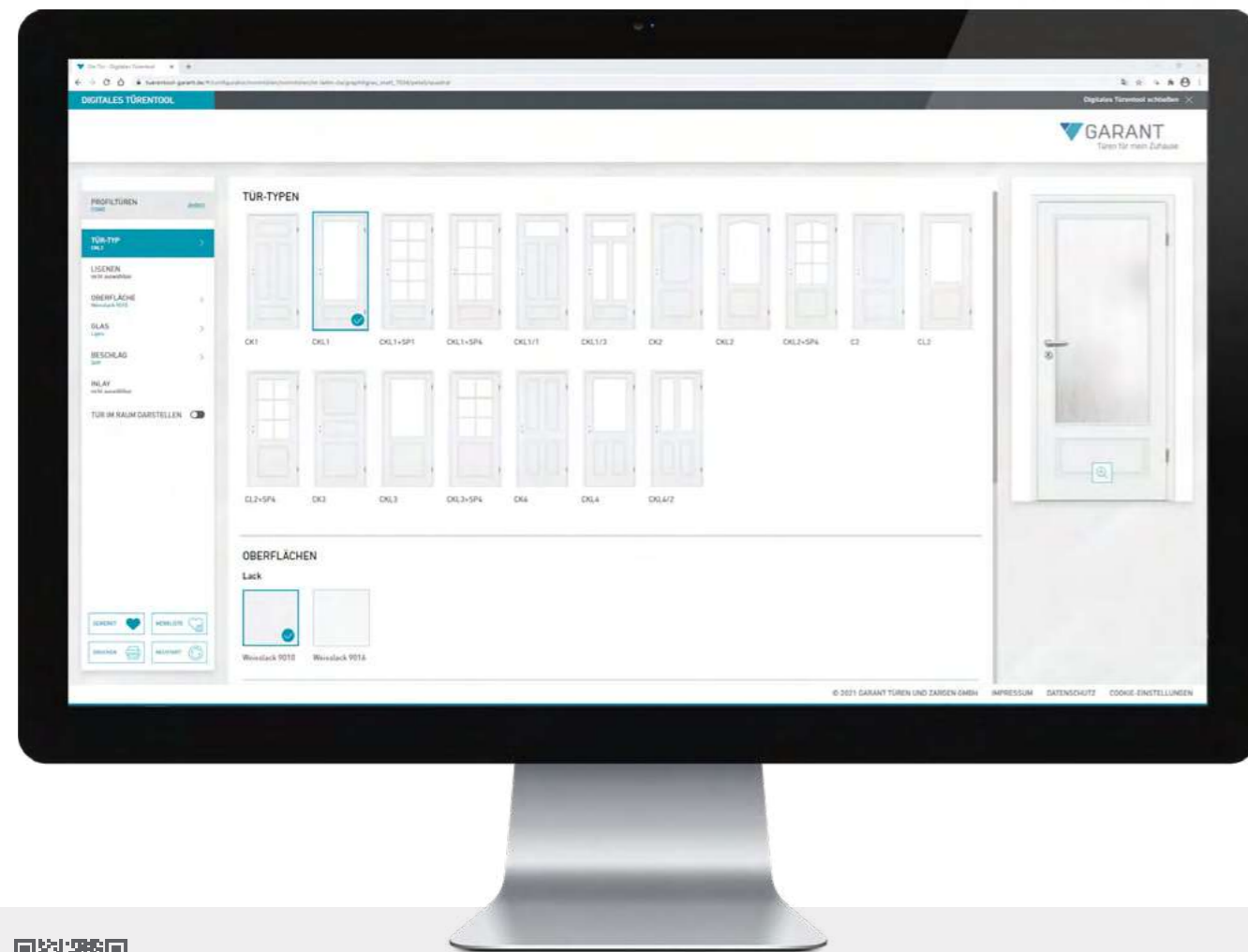

SCHRITT 1:

SO EINFACH FUNKTIONIERT DAS ONLINE-TÜRENTOOL VON GARANT

Im ersten Schritt können Sie oder auch der Kunde daheim zwischen den 4 verschiedenen Türkategorien Norm-, Stil-, Profil- und Designtüren auswählen. Einfach anklicken und Sie landen in der jeweiligen Übersicht. Dort konfigurieren Sie die Wunschtür für Ihren Kunden bis ins kleinste Detail. Ihr Kunde kann auch schon vorarbeiten und trifft eine erste Auswahl vorab zu Hause und Sie beraten detailliert weiter.

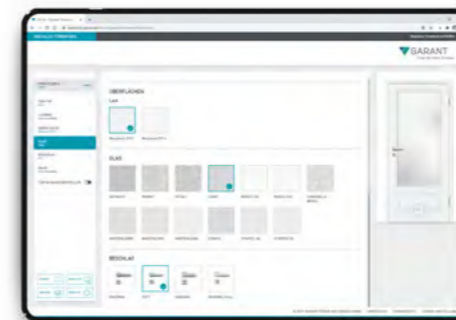

SCHRITT 2:

INDIVIDUALISIERUNG DER TÜR, JETZT AUCH MIT GRIFFWERK-BESCHLÄGEN

Innerhalb der jeweiligen Kategorie können Sie zwischen verschiedenen Türtypen wählen – zum Beispiel mit oder ohne Glas. Oder soll es vielleicht eine Oberfläche in Eiche oder Ahorn sein? Sie haben die Wahl zwischen verschiedensten Oberflächen, Gläsern und Beschlägen. Je nach Türtyp bieten sich unterschiedlich viele Auswahlmöglichkeiten.

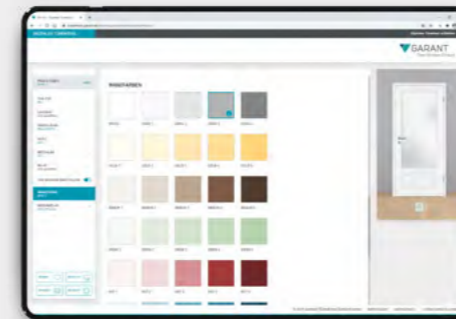

TÜR IM RAUM

Mit einem Klick sieht der Kunde mit der Funktion „Tür im Raum“ seine konfigurierte Wunschtür im Umfeld von Wand und Boden und kann so überprüfen, ob seine Vorstellungen auch stimmig zur Raumsituation – TÜR, BODEN, WAND – passen. Um die beste Kombination zu finden, können Wandfarbe und Bodenbelag farblich passend zur Tür getestet werden.



DAS ERGEBNIS:

BERATUNG UND BESTELLUNG BEIM FACHHÄNDLER

Wenn der Kunde seine Wunschtür zu Hause konfiguriert hat, kann er sie einfach auf den Merkzettel packen oder gleich ausdrucken und damit für eine tiefere Beratung und anschließende Bestellung zu Ihnen gehen.



KLICK 

Englische Übersetzung dieser Seite | English translation of this page

Das NORMTÜREN-Programm

The STANDARD DOOR range

Das gute und sichere Gefühl, die richtige Wahl getroffen zu haben:
Unsere NORMTÜREN sorgen jeden Tag für entspannte Wohnlichkeit.

You can be assured of making the right choice because the doors in our
STANDARD range provide relaxed comfort and convenience day after day.





NORMTÜREN
Weißlack 9016

STANDARD DOORS
White Varnish 9016

Türen, für die man sich immer wieder entscheiden würde: Einfach schön – und mit einer großen Auswahl an interessanten Oberflächen und Details.

Doors that people want to buy again and again: simply beautiful – with a comprehensive choice of interesting finishes and details.

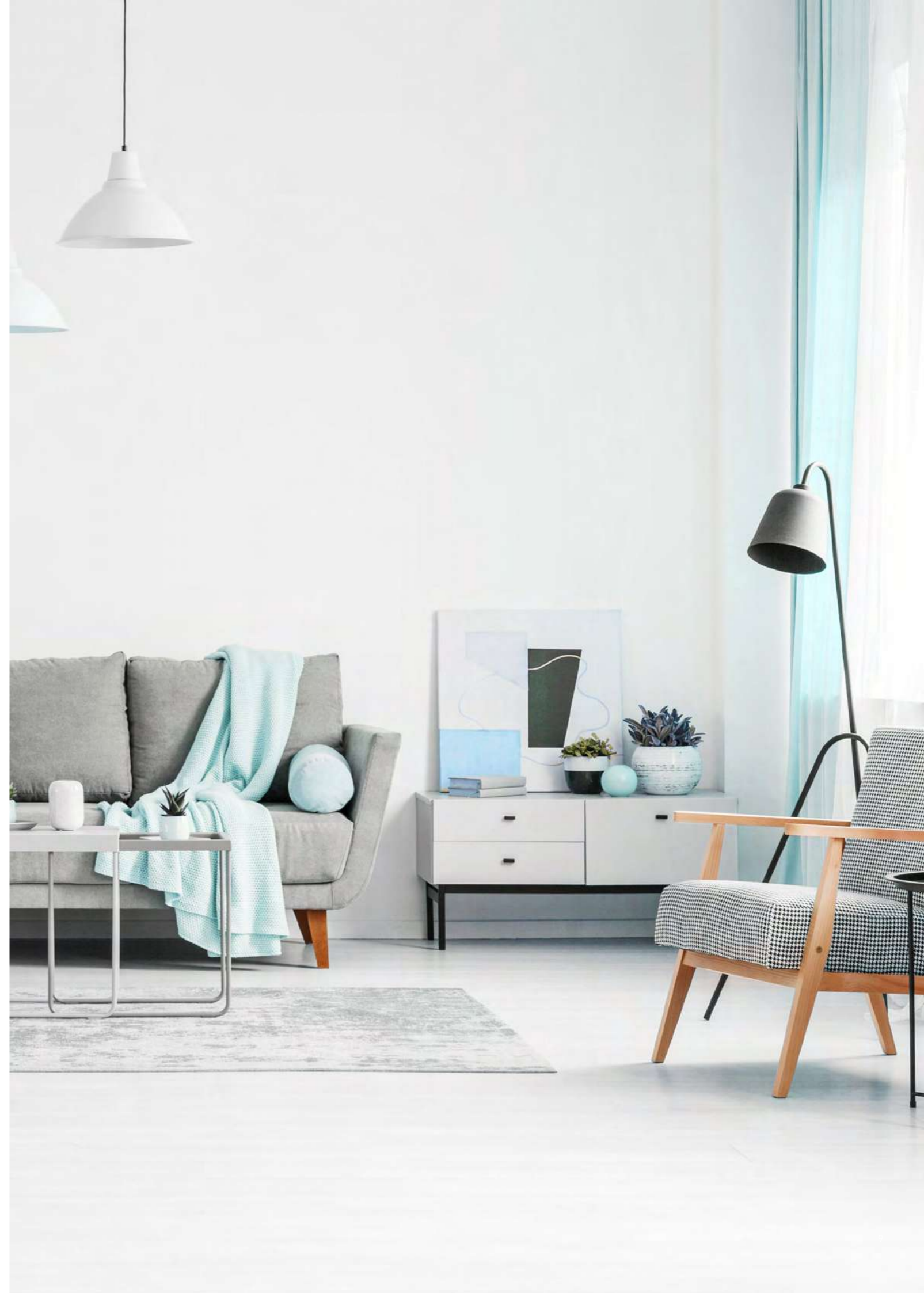

NORMTÜR
Weißlack 9016

Durchblick inklusive
With a vision

Unsere Weißlacktüren sorgen in Kombination mit Glas für moderne Raum-Transparenz.
Our white varnish doors provide modern transparency in combination with glass panels.

QUERSCHNITT | CROSS

KLEINE RUNDKANTE | SMALL ROUNDED EDGE

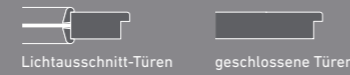

ECKIGE KANTE | SQUARE EDGE



BESCHLAG
NOVO

GRAPHITSCHWARZ
GRAPHITE BLACK



BB/PZ/WC

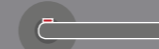

smart2lock

EDELSTAHL MATT
STAINLESS STEEL MATT



BB/PZ/WC



smart2lock



MODELL	1	NORMTÜR NT-DA
OBERFLÄCHE		Weißlack 9016
GLAS		-
ZARGE		KR1
BESCHLAG		NOVO, Graphitschwarz
MODEL		STANDARD DOOR NT-DA
FINISH		White varnish 9016
GLASS		-
FRAME		KR1
FITTINGS		NOVO, Graphite black

MODELL	2	NORMTÜR NT-LA11-DA
OBERFLÄCHE		Weißlack 9016
GLAS		SATINATO, Standard-Ornamentglas
ZARGE		KR1
BESCHLAG		NOVO, Graphitschwarz
MODEL		STANDARD DOOR NT-LA11-DA
FINISH		White varnish 9016
GLASS		SATINATO, standard patterned glass
FRAME		KR1
FITTINGS		NOVO, Graphite black

MODELL	3	NORMTÜR NT-LA-DA
OBERFLÄCHE		Weißlack 9016
GLAS		SATINATO, Standard-Ornamentglas
ZARGE		KR1
BESCHLAG		NOVO, Graphitschwarz
MODEL		STANDARD DOOR NT-LA-DA
FINISH		White varnish 9016
GLASS		SATINATO, standard patterned glass
FRAME		KR1
FITTINGS		NOVO, Graphite black

MODELL	4	NORMTÜR NT-LA-DA+SP4
OBERFLÄCHE		Weißlack 9016
GLAS		SATINATO, Standard-Ornamentglas
ZARGE		KR1
BESCHLAG		NOVO, Graphitschwarz
MODEL		STANDARD DOOR NT-LA-DA+SP4
FINISH		White varnish 9016
GLASS		SATINATO, standard patterned glass
FRAME		KR1
FITTINGS		NOVO, Graphite black

MODELL	5	NORMTÜR NT-LA4S-DA
OBERFLÄCHE		Weißlack 9016
GLAS		SATINATO, Standard-Ornamentglas
ZARGE		KR1
BESCHLAG		NOVO, Edelstahl Matt
MODEL		STANDARD DOOR NT-LA4S-DA
FINISH		White varnish 9016
GLASS		SATINATO, standard patterned glass
FRAME		KR1
FITTINGS		NOVO, Stainless steel matt

MODELL	6	NORMTÜR NT-LA4M-DA
OBERFLÄCHE		Weißlack 9016
GLAS		SATINATO, Standard-Ornamentglas
ZARGE		KR1
BESCHLAG		NOVO, Edelstahl Matt
MODEL		STANDARD DOOR NT-LA4M-DA
FINISH		White varnish 9016
GLASS		SATINATO, standard patterned glass
FRAME		KR1
FITTINGS		NOVO, Stainless steel matt

MODELL	7	NORMTÜR NT-LA2-DA
OBERFLÄCHE		Weißlack 9016
GLAS		STRIPES DQ, Siebdruck-Veredelung
ZARGE		KR1
BESCHLAG		NOVO, Edelstahl Matt
MODEL		STANDARD DOOR NT-LA2-DA
FINISH		White varnish 9016
GLASS		STRIPES DQ, screen printed décor
FRAME		KR1
FITTINGS		NOVO, Stainless steel matt



JETZT TESTEN
Im Online-Türentool „DieTÜR“ von GARANT kombinieren Sie mit einfachen Klicks Ihre individuelle Wunschtür.
TEST NOW
Use GARANT's online door tool 'DieTÜR' to create your own custom door in just a few clicks.



NORMTÜR
Weißlack 9010

Hier ist Entspannung
die Norm

Relaxation is the
norm here

So wird wohnliche Leichtigkeit ganz selbstverständlich.
Home comfort soon becomes.

QUERSCHNITT | CROSS

RUNDKANTE | ROUNDED EDGE



ECKIGE KANTE | SQUARE EDGE



BESCHLAG
MONO

GRAPHITSCHWARZ
GRAPHITE BLACK



BB/PZ/WC



smart2lock

EDELSTAHL MATT
STAINLESS STEEL MATT



BB/PZ/WC



smart2lock



MODELL	1	NORMTÜR NT-DA
OBERFLÄCHE		Weißlack 9010
GLAS		-
ZARGE		R1
BESCHLAG		MONO, Graphitschwarz
MODEL		STANDARD DOOR NT-DA
FINISH		White varnish 9010
GLASS		-
FRAME		R1
FITTINGS		MONO, Graphite black

MODELL	2	NORMTÜR NT-LA11-DA
OBERFLÄCHE		Weißlack 9010
GLAS		SATINATO, Standard-Ornamentglas
ZARGE		R1
BESCHLAG		MONO, Graphitschwarz
MODEL		STANDARD DOOR NT-LA11-DA
FINISH		White varnish 9010
GLASS		SATINATO, standard patterned glass
FRAME		R1
FITTINGS		MONO, Graphite black

MODELL	3	NORMTÜR NT-LA-DA
OBERFLÄCHE		Weißlack 9010
GLAS		SATINATO, Standard-Ornamentglas
ZARGE		R1
BESCHLAG		MONO, Graphitschwarz
MODEL		STANDARD DOOR NT-LA-DA
FINISH		White varnish 9010
GLASS		SATINATO, standard patterned glass
FRAME		R1
FITTINGS		MONO, Graphite black

MODELL	4	NORMTÜR NT-LA-DA+SP4
OBERFLÄCHE		Weißlack 9010
GLAS		SATINATO, Standard-Ornamentglas
ZARGE		R1
BESCHLAG		MONO, Graphitschwarz
MODEL		STANDARD DOOR NT-LA-DA+SP4
FINISH		White varnish 9010
GLASS		SATINATO, standard patterned glass
FRAME		R1
FITTINGS		MONO, Graphite black

MODELL	5	NORMTÜR NT-LA4S-DA
OBERFLÄCHE		Weißlack 9010
GLAS		SATINATO, Standard-Ornamentglas
ZARGE		R1
BESCHLAG		MONO, Edelstahl Matt
MODEL		STANDARD DOOR NT-LA4S-DA
FINISH		White varnish 9010
GLASS		SATINATO, standard patterned glass
FRAME		R1
FITTINGS		MONO, Stainless steel matt

MODELL	6	NORMTÜR NT-LA4M-DA
OBERFLÄCHE		Weißlack 9010
GLAS		SATINATO, Standard-Ornamentglas
ZARGE		R1
BESCHLAG		MONO, Edelstahl Matt
MODEL		STANDARD DOOR NT-LA4M-DA
FINISH		White varnish 9010
GLASS		SATINATO, standard patterned glass
FRAME		R1
FITTINGS		MONO, Stainless steel matt

MODELL	7	NORMTÜR NT-LA2-DA
OBERFLÄCHE		Weißlack 9010
GLAS		PETALI, Design-Ornamentglas
ZARGE		R1
BESCHLAG		MONO, Edelstahl Matt
MODEL		STANDARD DOOR NT-LA2-DA
FINISH		White varnish 9010
GLASS		PETALI, design patterned glass
FRAME		R1
FITTINGS		MONO, Stainless steel matt



JETZT TESTEN
Im Online-Türentool „DieTÜR“ von GARANT kombinieren Sie mit einfachen Klicks Ihre individuelle Wunschtür.
TEST NOW
Use GARANT's online door tool 'DieTÜR' to create your own custom door in just a few clicks.

Gesamtübersicht NORMTÜREN-Programm

Overview of the STANDARD DOOR range

NORMTÜREN | STANDARD DOORS

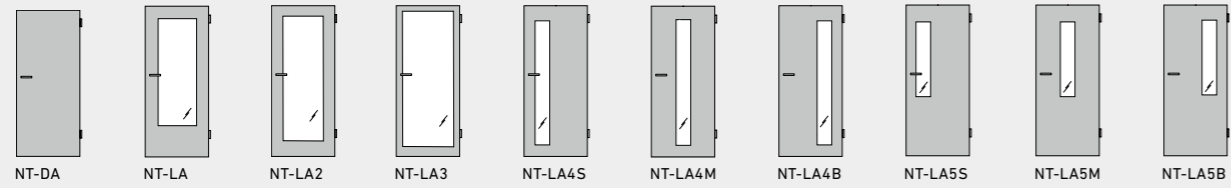

NT-DA NT-LA NT-LA2 NT-LA3 NT-LA4S NT-LA4M NT-LA4B NT-LA5S NT-LA5M NT-LA5B

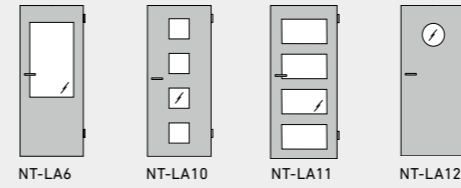

NT-LA6 NT-LA10 NT-LA11 NT-LA12

OBERFLÄCHEN
FINISHES

WEISSLACK 9016
WHITE VARNISH 9016

TÜRKANTEN
EDGES

OBERFLÄCHEN
FINISHES

WEISSLACK 9010
WHITE VARNISH 9010

TÜRKANTEN
EDGES

GLÄSER | GLASS PANELS

MODERNE ORNAMENTGLÄSER | MODERN PATTERNED GLASS PANELS

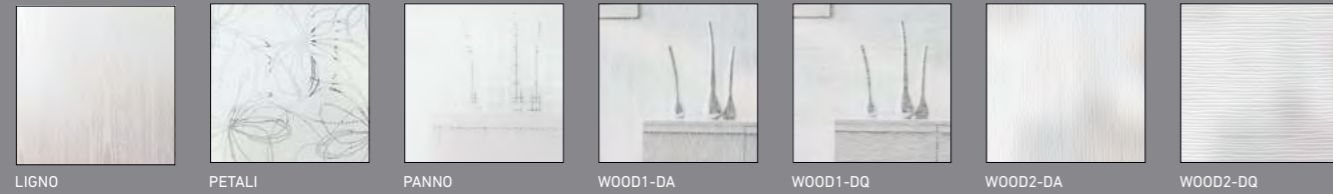

LIGNO PETALI PANNO WOOD1-DA WOOD1-DQ WOOD2-DA WOOD2-DQ

DESIGNGLÄSER – SIEBDRUCK-VEREDELUNG | DESIGN GLASS PANELS – SCREEN PRINTED DÉCOR



STRATO STRIPES-DA STRIPES-DQ

KLASSISCHE ORNAMENTGLÄSER | CLASSIC PATTERNED GLASS PANELS



CHINCHILLA WEISS CHINCHILLA WHITE KLARGLAS TRANSPARENT GLASS SATINATO MASTERCARRÉ WEISS MASTERCARRÉ WHITE MASTERLIGNE MASTERPOINT

TOP-BESCHLÄGE | TOP-FERRURE

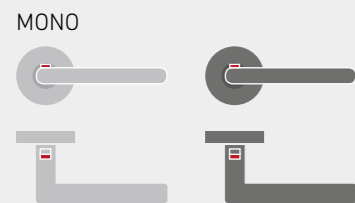

MONO
WÄHLBAR IN EDELSTAHL MATT ODER GRAPHITSCHWARZ
AVAILABLE IN STAINLESS STEEL MATT OR GRAPHITE BLACK

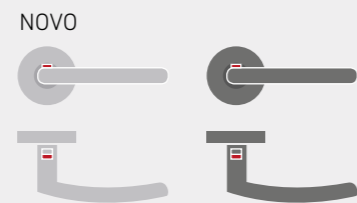

NOVO
WÄHLBAR IN EDELSTAHL MATT ODER GRAPHITSCHWARZ
AVAILABLE IN STAINLESS STEEL MATT OR GRAPHITE BLACK

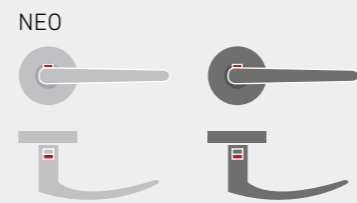

NEO
WÄHLBAR IN EDELSTAHL MATT ODER GRAPHITSCHWARZ
AVAILABLE IN STAINLESS STEEL MATT OR GRAPHITE BLACK

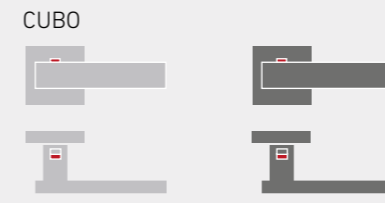

CUBO
WÄHLBAR IN EDELSTAHL MATT ODER GRAPHITSCHWARZ
AVAILABLE IN STAINLESS STEEL MATT OR GRAPHITE BLACK

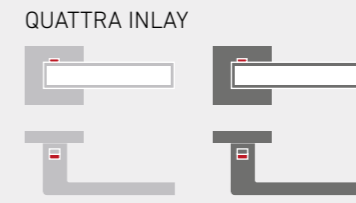

QUATTRA INLAY
WÄHLBAR IN EDELSTAHOPTIK MATT ODER GRAPHITSCHWARZ
AVAILABLE IN MATT STAINLESS STEEL LOOK OR GRAPHITE BLACK

INLAYS | INLAYS



Das DESIGNTÜREN-Programm

The DESIGN DOOR range

RAUM FÜR DESIGN

Mit den Modellen unseres DESIGNTÜREN-Programms werden Wohnwelten gestaltet.

SPACE FOR DESIGN

The models in our DESIGN DOOR range can be used to create living spaces.





AURA
Weißlack 9016

AURA
White varnish 9016

Starke Inszenierung von Tür und Raum
mit einzigartiger Ausstrahlung.
Both the door and the room make a strong
statement and have unique appeal.



AURA
Weißlack 9016

Atmosphäre auf ganzer Linie

Impressive atmosphere

Ausdrucksstark wohnen mit der edlen Design-Kombination aus Weißlack und Glas.
Enjoy an expressive home environment featuring the exclusive combination of white varnish and glass.

LISENEN | PILASTER STRIPS

Lisene Matt-Schwarz

Lisene Edelstahloptik

QUERSCHNITT | CROSS

KLEINE RUNDKANTE | SMALL ROUNDED EDGE



Lichtausschnitt-Türen



geschlossene Türen



BESCHLAG
QUATTRA INLAY

GRAPHITSCHWARZ
GRAPHITE BLACK



BB/PZ/WC



smart2lock

EDELSTAHOPTIK MATT
MATT STAINLESS STEEL LOOK



BB/PZ/WC



smart2lock



MODELL	1 AURA A830
OBERFLÄCHE	Weißlack 9016
GLAS	-
ZARGE	KR1
BESCHLAG	QUATTRA INLAY, Graphitschwarz
MODEL	AURA A830
FINISH	White varnish 9016
GLASS	-
FRAME	KR1
FITTINGS	QUATTRA INLAY, Graphite black

MODELL	2 AURA A830-LA4M
OBERFLÄCHE	Weißlack 9016
GLAS	SATINATO, Standard-Ornamentglas
ZARGE	KR1
BESCHLAG	QUATTRA INLAY, Graphitschwarz
MODEL	AURA A830-LA4M
FINISH	White varnish 9016
GLASS	SATINATO, standard patterned glass
FRAME	KR1
FITTINGS	QUATTRA INLAY, Graphite black

MODELL	3 AURA A834
OBERFLÄCHE	Weißlack 9016
GLAS	-
ZARGE	KR1
BESCHLAG	QUATTRA INLAY, Graphitschwarz
MODEL	AURA A834
FINISH	White varnish 9016
GLASS	-
FRAME	KR1
FITTINGS	QUATTRA INLAY, Graphite black

MODELL	4 AURA A834-LA4S
OBERFLÄCHE	Weißlack 9016
GLAS	SATINATO, Standard-Ornamentglas
ZARGE	KR1
BESCHLAG	QUATTRA INLAY, Graphitschwarz
MODEL	AURA A834-LA4S
FINISH	White varnish 9016
GLASS	SATINATO, standard patterned glass
FRAME	KR1
FITTINGS	QUATTRA INLAY, Graphite black

MODELL	5 AURA A850
OBERFLÄCHE	Weißlack 9016
GLAS	-
ZARGE	KR1
BESCHLAG	QUATTRA INLAY, Edelstahloptik Matt
MODEL	AURA A850
FINISH	White varnish 9016
GLASS	-
FRAME	KR1
FITTINGS	QUATTRA INLAY, Matt stainless steel look

MODELL	6 AURA A851
OBERFLÄCHE	Weißlack 9016
GLAS	-
ZARGE	KR1
BESCHLAG	QUATTRA INLAY, Edelstahloptik Matt
MODEL	AURA A851
FINISH	White varnish 9016
GLASS	-
FRAME	KR1
FITTINGS	QUATTRA INLAY, Matt stainless steel look

MODELL	7 AURA A831
OBERFLÄCHE	Weißlack 9016
GLAS	-
ZARGE	KR1
BESCHLAG	QUATTRA INLAY, Edelstahloptik Matt
MODEL	AURA A831
FINISH	White varnish 9016
GLASS	-
FRAME	KR1
FITTINGS	QUATTRA INLAY, Matt stainless steel look



JETZT TESTEN
Im Online-Türentool „DieTÜR“ von GARANT kombinieren Sie mit einfachen Klicks Ihre individuelle Wunschtür.
TEST NOW
Use GARANT's online door tool 'DieTÜR' to create your own custom door in just a few clicks.

AURA
Weißlack 9010

Elegante Abwechslung An elegant change

Weißer Farbe im reizvollen Kontrast zu Mobiliar und Wohnaccessoires.
White varnish contrasts beautifully with the furniture and interior design features.

LISENEN | PILASTER STRIPS

Lisene Matt-Schwarz

Lisene Edelstahloptik

QUERSCHNITT | CROSS

RUNDKANTE | ROUNDED EDGE



Lichtausschnitt-Türen geschlossene Türen



BESCHLAG
CUBO

GRAPHITSCHWARZ
GRAPHITE BLACK



BB/PZ/WC



smart2lock

EDELSTAHL MATT
STAINLESS STEEL MATT



BB/PZ/WC



smart2lock



MODELL	1 AURA A830
OBERFLÄCHE	Weißlack 9010
GLAS	-
ZARGE	R1
BESCHLAG	CUBO, Graphitschwarz
MODEL	AURA A830
FINISH	White varnish 9010
GLASS	-
FRAME	R1
FITTINGS	CUBO, Graphite black

MODELL	2 AURA A830-LA4M
OBERFLÄCHE	Weißlack 9010
GLAS	SATINATO, Standard-Ornamentglas
ZARGE	R1
BESCHLAG	CUBO, Graphitschwarz
MODEL	AURA A830-LA4M
FINISH	White varnish 9010
GLASS	SATINATO, standard patterned glass
FRAME	R1
FITTINGS	CUBO, Graphite black

MODELL	3 AURA A834
OBERFLÄCHE	Weißlack 9010
GLAS	-
ZARGE	R1
BESCHLAG	CUBO, Graphitschwarz
MODEL	AURA A834
FINISH	White varnish 9010
GLASS	-
FRAME	R1
FITTINGS	CUBO, Graphite black

MODELL	4 AURA A834-LA4S
OBERFLÄCHE	Weißlack 9010
GLAS	SATINATO, Standard-Ornamentglas
ZARGE	R1
BESCHLAG	CUBO, Graphitschwarz
MODEL	AURA A834-LA4S
FINISH	White varnish 9010
GLASS	SATINATO, standard patterned glass
FRAME	R1
FITTINGS	CUBO, Graphite black

MODELL	5 AURA A850
OBERFLÄCHE	Weißlack 9010
GLAS	-
ZARGE	R1
BESCHLAG	CUBO, Edelstahl Matt
MODEL	AURA A850
FINISH	White varnish 9010
GLASS	-
FRAME	R1
FITTINGS	CUBO, Stainless steel matt

MODELL	6 AURA A851
OBERFLÄCHE	Weißlack 9010
GLAS	-
ZARGE	R1
BESCHLAG	CUBO, Edelstahl Matt
MODEL	AURA A851
FINISH	White varnish 9010
GLASS	-
FRAME	R1
FITTINGS	CUBO, Stainless steel matt

MODELL	7 AURA A831
OBERFLÄCHE	Weißlack 9010
GLAS	-
ZARGE	R1
BESCHLAG	CUBO, Edelstahl Matt
MODEL	AURA A831
FINISH	White varnish 9010
GLASS	-
FRAME	R1
FITTINGS	CUBO, Stainless steel matt



JETZT TESTEN
Im Online-Türentool „DieTÜR“ von GARANT kombinieren Sie mit einfachen Klicks Ihre individuelle Wunschtür.
TEST NOW
Use GARANT's online door tool 'DieTÜR' to create your own custom door in just a few clicks.

Gesamtübersicht DESIGNTÜREN-Programm

Overview of the DESIGN DOOR range

AURA | AURA



A310 A830 A830-LA4M A831 A832 A832-LA4M A833 A833-LA4M A834 A834-LA4S A850 A851

OBERFLÄCHEN
FINISHES



TÜRKANTEN
EDGES



OBERFLÄCHEN
FINISHES



TÜRKANTEN
EDGES



MODERNE ORNAMENTGLÄSER | MODERN PATTERNED GLASS PANELS

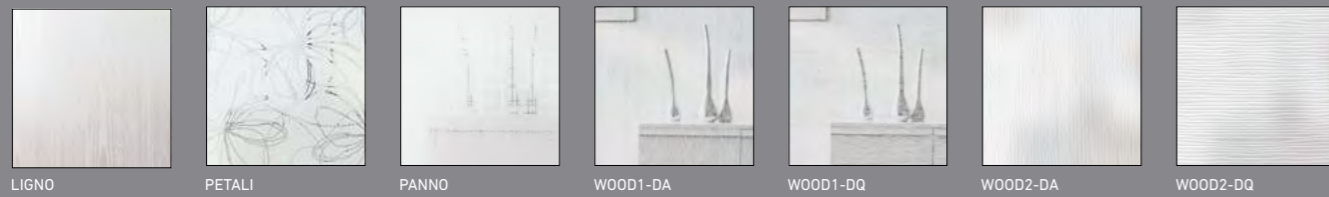

LIGNO PETALI PANNO WOOD1-DA WOOD1-DQ WOOD2-DA WOOD2-DQ

DESIGNGLÄSER – SIEBDRUCK-VEREDELUNG | DESIGN GLASS PANELS – SCREEN PRINTED DÉCOR

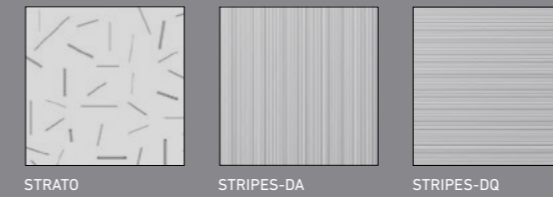

STRATO STRIPES-DA STRIPES-DQ

GLÄSER | VERRES

KLASSISCHE ORNAMENTGLÄSER | CLASSIC PATTERNED GLASS PANELS



CHINCHILLA WEISS CHINCHILLA WHITE KLARGLAS TRANSPARENT GLASS SATINATO MASTERCARRÉ WEISS MASTERCARRÉ WHITE MASTERLIGNE MASTERPOINT

TOP-BESCHLÄGE | TOP-FERRURE

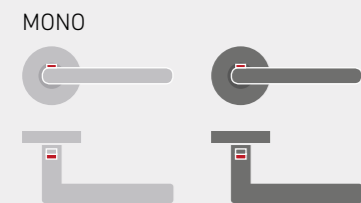

WÄHLBAR IN EDELSTAHL MATT ODER GRAPHITSCHWARZ
AVAILABLE IN STAINLESS STEEL MATT OR GRAPHITE BLACK

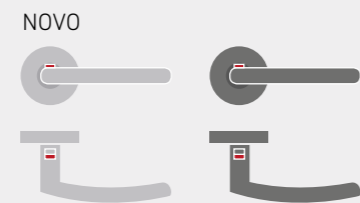

WÄHLBAR IN EDELSTAHL MATT ODER GRAPHITSCHWARZ
AVAILABLE IN STAINLESS STEEL MATT OR GRAPHITE BLACK

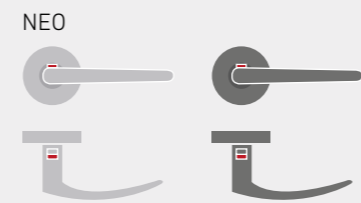

WÄHLBAR IN EDELSTAHL MATT ODER GRAPHITSCHWARZ
AVAILABLE IN STAINLESS STEEL MATT OR GRAPHITE BLACK

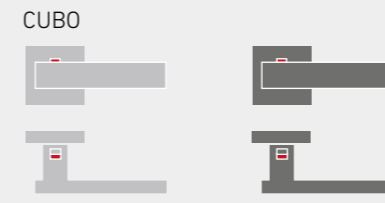

WÄHLBAR IN EDELSTAHL MATT ODER GRAPHITSCHWARZ
AVAILABLE IN STAINLESS STEEL MATT OR GRAPHITE BLACK

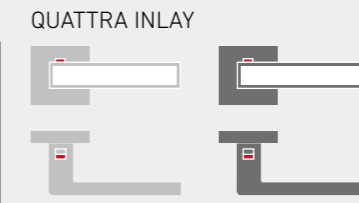

WÄHLBAR IN EDELSTAHL OPTIK MATT ODER GRAPHITSCHWARZ
AVAILABLE IN MATT STAINLESS STEEL LOOK OR GRAPHITE BLACK

INLAYS | INLAYS



Das PROFILTÜREN-Programm

The PROFILE DOOR range

TRÄUME IN WEISS ERLEBEN:

Unsere PROFILTÜREN mit edlen Weißlackoberflächen.

EXPERIENCE DREAMS IN WHITE:

our PROFILE DOORS with elegant white varnish finishes.





MILANO
Weißlack 9016
MILANO
White varnish 9016

Mit Leichtigkeit und Profil ganz selbstverständlich inszeniert.

A convincingly light design featuring profiled sections.





MILANO
Weißlack 9016

Eine Optik mit Mehrwert Value-adding aesthetics

Lichtausschnitt-Modelle begeistern durch eine flächenbündige Glasleiste.
The models with vision panels feature a flush-fitted glass strip.

QUERSCHNITT | CROSS

KLEINE RUNDKANTE | SMALL ROUNDED EDGE

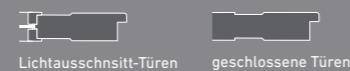

BESCHLAG
NOVO

GRAPHITSCHWARZ
GRAPHITE BLACK



BB/PZ/WC



smart2lock

EDELSTAHL MATT
STAINLESS STEEL MATT



BB/PZ/WC



smart2lock



MODELL	1 MILANO M3/2
OBERFLÄCHE	Weißlack 9016
GLAS	-
ZARGE	KR1
BESCHLAG	NOVO, Graphitschwarz
MODEL	MILANO M3/2
FINISH	White varnish 9016
GLASS	-
FRAME	KR1
FITTINGS	NOVO, Graphite black

MODELL	2 MILANO ML3/2
OBERFLÄCHE	Weißlack 9016
GLAS	SATINATO, Standard-Ornamentglas
ZARGE	KR1
BESCHLAG	NOVO, Graphitschwarz
MODEL	MILANO ML3/2
FINISH	White varnish 9016
GLASS	SATINATO, standard patterned glass
FRAME	KR1
FITTINGS	NOVO, Graphite black

MODELL	3 MILANO ML2/1
OBERFLÄCHE	Weißlack 9016
GLAS	SATINATO, Standard-Ornamentglas
ZARGE	KR1
BESCHLAG	NOVO, Graphitschwarz
MODEL	MILANO ML2/1
FINISH	White varnish 9016
GLASS	SATINATO, standard patterned glass
FRAME	KR1
FITTINGS	NOVO, Graphite black

MODELL	4 MILANO M2
OBERFLÄCHE	Weißlack 9016
GLAS	-
ZARGE	KR1
BESCHLAG	NOVO, Graphitschwarz
MODEL	MILANO M2
FINISH	White varnish 9016
GLASS	-
FRAME	KR1
FITTINGS	NOVO, Graphite black

MODELL	5 MILANO ML2
OBERFLÄCHE	Weißlack 9016
GLAS	SATINATO, Standard-Ornamentglas
ZARGE	KR1
BESCHLAG	NOVO, Edelstahl Matt
MODEL	MILANO ML2
FINISH	White varnish 9016
GLASS	SATINATO, standard patterned glass
FRAME	KR1
FITTINGS	NOVO, Stainless steel matt

MODELL	6 MILANO M1
OBERFLÄCHE	Weißlack 9016
GLAS	-
ZARGE	KR1
BESCHLAG	NOVO, Edelstahl Matt
MODEL	MILANO M1
FINISH	White varnish 9016
GLASS	-
FRAME	KR1
FITTINGS	NOVO, Stainless steel matt

MODELL	7 MILANO ML1
OBERFLÄCHE	Weißlack 9016
GLAS	WOOD2-DQ, Design-Ornamentglas
ZARGE	KR1
BESCHLAG	NOVO, Edelstahl Matt
MODEL	MILANO ML1
FINISH	White varnish 9016
GLASS	WOOD2-DQ, design patterned glass
FRAME	KR1
FITTINGS	NOVO, Stainless steel matt



JETZT TESTEN
Im Online-Türentool „DieTÜR“ von GARANT kombinieren Sie mit einfachen Klicks Ihre individuelle Wunschtür.
TEST NOW
Use GARANT's online door tool "DieTÜR" to create your own custom door in just a few clicks.



MILANO
Weißlack 9010

Ausgezeichneter Geschmack Excellent taste

Mit den Weißlacktüren MILANO Formgefühl beweisen.
The MILANO white varnish doors boast a harmonious design.

QUERSCHNITT | CROSS

RUNDKANTE | ROUNDED EDGE



BESCHLAG
NEO

GRAPHITSCHWARZ
GRAPHITE BLACK



BB/PZ/WC



smart2lock

EDELSTAHL MATT
STAINLESS STEEL MATT



BB/PZ/WC



smart2lock



MODELL	1 MILANO M3/2
OBERFLÄCHE	Weißlack 9010
GLAS	-
ZARGE	R1
BESCHLAG	NEO, Graphitschwarz
MODEL	MILANO M3/2
FINISH	White varnish 9010
GLASS	-
FRAME	R1
FITTINGS	NEO, Graphite black

MODELL	2 MILANO ML3/2
OBERFLÄCHE	Weißlack 9010
GLAS	SATINATO, Standard-Ornamentglas
ZARGE	R1
BESCHLAG	NEO, Graphitschwarz
MODEL	MILANO ML3/2
FINISH	White varnish 9010
GLASS	SATINATO, standard patterned glass
FRAME	R1
FITTINGS	NEO, Graphite black

MODELL	3 MILANO M2/1
OBERFLÄCHE	Weißlack 9010
GLAS	-
ZARGE	R1
BESCHLAG	NEO, Graphitschwarz
MODEL	MILANO M2/1
FINISH	White varnish 9010
GLASS	-
FRAME	R1
FITTINGS	NEO, Graphite black

MODELL	4 MILANO M2
OBERFLÄCHE	Weißlack 9010
GLAS	-
ZARGE	R1
BESCHLAG	NEO, Graphitschwarz
MODEL	MILANO M2
FINISH	White varnish 9010
GLASS	-
FRAME	R1
FITTINGS	NEO, Graphite black

MODELL	5 MILANO ML2
OBERFLÄCHE	Weißlack 9010
GLAS	SATINATO, Standard-Ornamentglas
ZARGE	R1
BESCHLAG	NEO, Edelstahl Matt
MODEL	MILANO ML2
FINISH	White varnish 9010
GLASS	SATINATO, standard patterned glass
FRAME	R1
FITTINGS	NEO, Stainless steel matt

MODELL	6 MILANO M1
OBERFLÄCHE	Weißlack 9010
GLAS	-
ZARGE	R1
BESCHLAG	NEO, Edelstahl Matt
MODEL	MILANO M1
FINISH	White varnish 9010
GLASS	-
FRAME	R1
FITTINGS	NEO, Stainless steel matt

MODELL	7 MILANO ML1
OBERFLÄCHE	Weißlack 9010
GLAS	PETALI, Design-Ornamentglas
ZARGE	R1
BESCHLAG	NEO, Edelstahl Matt
MODEL	MILANO ML1
FINISH	White varnish 9010
GLASS	PETALI, design patterned glass
FRAME	R1
FITTINGS	NEO, Stainless steel matt



JETZT TESTEN
Im Online-Türentool „DieTÜR“ von GARANT kombinieren Sie mit einfachen Klicks Ihre individuelle Wunschtür.
TEST NOW
Use GARANT's online door tool 'DieTÜR' to create your own custom door in just a few clicks.

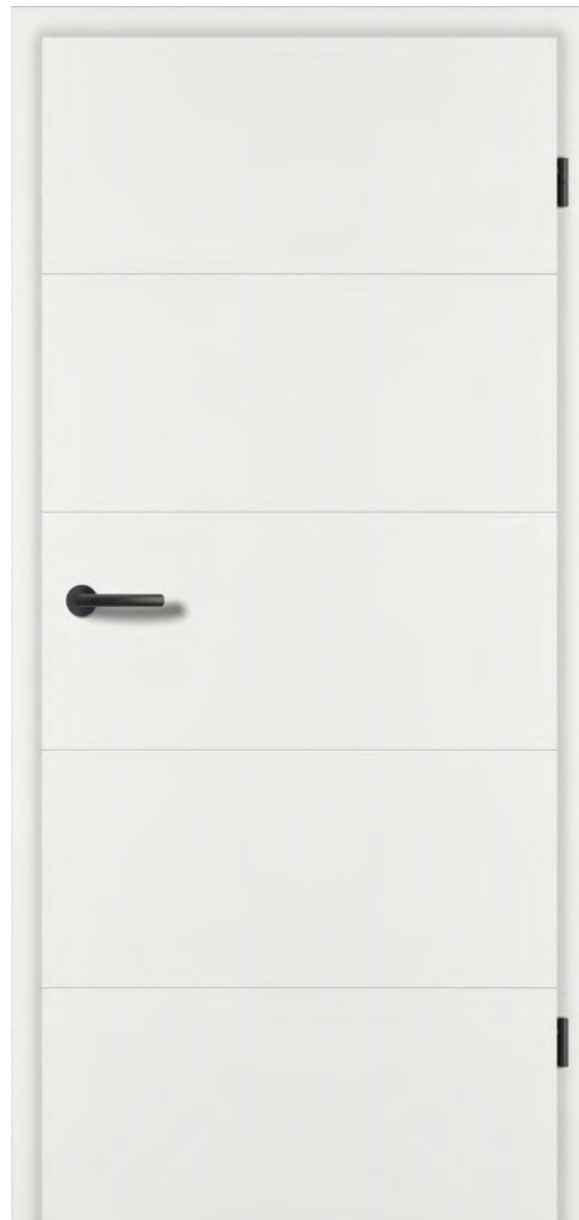

RIVA
Weißlack 9016

RIVA
White varnish 9016

Hochwertige Weißlacktüren für eine vielseitige
und hochwertige Raumgestaltung.

Premium quality white varnish doors for
versatile premium interior design.



RIVA
Weißlack 9016

Akzente für jede Raumgestaltung

Stylish highlights
for every room

Türen für eine individuelle Note.
Doors that add a personal touch.

QUERSCHNITT | CROSS

KLEINE RUNDKANTE | SMALL ROUNDED EDGE

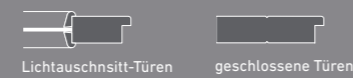

BESCHLAG
NOVO

GRAPHITSCHWARZ
GRAPHITE BLACK



BB/PZ/WC



smart2lock

EDELSTAHL MATT
STAINLESS STEEL MATT



BB/PZ/WC



smart2lock



MODELL	1 RIVA R11
OBERFLÄCHE	Weißlack 9016
GLAS	-
ZARGE	KR1
BESCHLAG	NOVO, Graphitschwarz
MODEL	RIVA R11
FINISH	White varnish 9016
GLASS	-
FRAME	KR1
FITTINGS	NOVO, Graphite black

MODELL	2 RIVA R11-LA4S
OBERFLÄCHE	Weißlack 9016
GLAS	SATINATO, Standard-Ornamentglas
ZARGE	KR1
BESCHLAG	NOVO, Graphitschwarz
MODEL	RIVA R11-LA4S
FINISH	White varnish 9016
GLASS	SATINATO, standard patterned glass
FRAME	KR1
FITTINGS	NOVO, Graphite black

MODELL	3 RIVA R18
OBERFLÄCHE	Weißlack 9016
GLAS	-
ZARGE	KR1
BESCHLAG	NOVO, Graphitschwarz
MODEL	RIVA R18
FINISH	White varnish 9016
GLASS	-
FRAME	KR1
FITTINGS	NOVO, Graphite black

MODELL	4 RIVA R18-LA4M
OBERFLÄCHE	Weißlack 9016
GLAS	SATINATO, Standard-Ornamentglas
ZARGE	KR1
BESCHLAG	NOVO, Graphitschwarz
MODEL	RIVA R18-LA4M
FINISH	White varnish 9016
GLASS	SATINATO, standard patterned glass
FRAME	KR1
FITTINGS	NOVO, Graphite black

MODELL	5 RIVA R14
OBERFLÄCHE	Weißlack 9016
GLAS	-
ZARGE	KR1
BESCHLAG	NOVO, Edelstahl Matt
MODEL	RIVA R14
FINISH	White varnish 9016
GLASS	-
FRAME	KR1
FITTINGS	NOVO, Stainless steel matt

MODELL	6 RIVA R11
OBERFLÄCHE	Weißlack 9016
GLAS	-
ZARGE	KR1
BESCHLAG	NOVO, Edelstahl Matt
MODEL	RIVA R11
FINISH	White varnish 9016
GLASS	-
FRAME	KR1
FITTINGS	NOVO, Stainless steel matt

MODELL	7 RIVA R11-LA2
OBERFLÄCHE	Weißlack 9016
GLAS	STRIPES DA, Siebdruck-Veredelung
ZARGE	KR1
BESCHLAG	NOVO, Edelstahl Matt
MODEL	RIVA R11-LA2
FINISH	White varnish 9016
GLASS	STRIPES DA, screen printed décor
FRAME	KR1
FITTINGS	NOVO, Stainless steel matt



JETZT TESTEN
Im Online-Türentool „DieTÜR“ von GARANT kombinieren Sie mit einfachen Klicks Ihre individuelle Wunschtür.
TEST NOW
Use GARANT's online door tool 'DieTÜR' to create your own custom door in just a few clicks.

RIVA
Weißlack 9010

Unbeschwertes Lebensgefühl Carefree living

Klare Linienführung plus klare Details für ein starkes Gesamtbild.
Clear lines and clear details make a powerful statement.

QUERSCHNITT | CROSS

RUNDKANTE | ROUNDED EDGE



Lichtausschnitt-Türen



geschlossene Türen



BESCHLAG
QUATTRA INLAY

GRAPHITSCHWARZ
GRAPHITE BLACK



BB/PZ/WC



smart2lock

EDELSTAHOPTIK MATT
MATT STAINLESS STEEL LOOK



BB/PZ/WC



smart2lock



MODELL	1 RIVA R1
OBERFLÄCHE	Weißlack 9010
GLAS	-
ZARGE	R1
BESCHLAG	QUATTRA INLAY, Graphitschwarz
MODEL	RIVA R1
FINISH	White varnish 9010
GLASS	-
FRAME	R1
FITTINGS	QUATTRA INLAY, Graphite black

MODELL	2 RIVA R11-LA4S
OBERFLÄCHE	Weißlack 9010
GLAS	SATINATO, Standard-Ornamentglas
ZARGE	R1
BESCHLAG	QUATTRA INLAY, Graphitschwarz
MODEL	RIVA R11-LA4S
FINISH	White varnish 9010
GLASS	SATINATO, standard patterned glass
FRAME	R1
FITTINGS	QUATTRA INLAY, Graphite black

MODELL	3 RIVA R18
OBERFLÄCHE	Weißlack 9010
GLAS	-
ZARGE	R1
BESCHLAG	QUATTRA INLAY, Graphitschwarz
MODEL	RIVA R18
FINISH	White varnish 9010
GLASS	-
FRAME	R1
FITTINGS	QUATTRA INLAY, Graphite black

MODELL	4 RIVA R18-LA4M
OBERFLÄCHE	Weißlack 9010
GLAS	SATINATO, Standard-Ornamentglas
ZARGE	R1
BESCHLAG	QUATTRA INLAY, Graphitschwarz
MODEL	RIVA R18-LA4M
FINISH	White varnish 9010
GLASS	SATINATO, standard patterned glass
FRAME	R1
FITTINGS	QUATTRA INLAY, Graphite black

MODELL	5 RIVA R14
OBERFLÄCHE	Weißlack 9010
GLAS	-
ZARGE	R1
BESCHLAG	QUATTRA INLAY, Edelstahloptik Matt
MODEL	RIVA R14
FINISH	White varnish 9010
GLASS	-
FRAME	R1
FITTINGS	QUATTRA INLAY, Matt stainless steel look

MODELL	6 RIVA R11
OBERFLÄCHE	Weißlack 9010
GLAS	-
ZARGE	R1
BESCHLAG	QUATTRA INLAY, Edelstahloptik Matt
MODEL	RIVA R11
FINISH	White varnish 9010
GLASS	-
FRAME	R1
FITTINGS	QUATTRA INLAY, Matt stainless steel look

MODELL	7 RIVA R111-LA2
OBERFLÄCHE	Weißlack 9010
GLAS	STRATO, Siebdruck-Veredelung
ZARGE	R1
BESCHLAG	QUATTRA INLAY, Edelstahloptik Matt
MODEL	RIVA R111-LA2
FINISH	White varnish 9010
GLASS	STRATO, screen printed décor
FRAME	R1
FITTINGS	QUATTRA INLAY, Matt stainless steel look



JETZT TESTEN
Im Online-Türentool „DieTÜR“ von GARANT kombinieren Sie mit einfachen Klicks Ihre individuelle Wunschtür.
TEST NOW
Use GARANT's online door tool 'DieTÜR' to create your own custom door in just a few clicks.



COMO
Weißlack 9016

COMO
White varnish 9016

Das Plus für jeden Raum: Klassisch und modern,
zurückhaltend und stilsicher.

It enhances any room: classic and modern,
understated or stylish.





COMO
Weißlack 9016

Vielseitig elegant
Elegant versatility

Zeitlose Kassettenoptik unterstreicht die Schönheit der Einrichtung.
A timeless panelled look underlines the beauty of the interior furnishings.

QUERSCHNITT | CROSS

KLEINE RUNDKANTE | SMALL ROUNDED EDGE

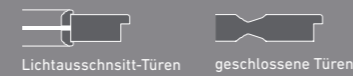

BESCHLAG
MONO

GRAPHITSCHWARZ
GRAPHITE BLACK



BB/PZ/WC



smart2lock

EDELSTAHL MATT
STAINLESS STEEL MATT



BB/PZ/WC



smart2lock



MODELL	1	COMO CK3
OBERFLÄCHE		Weißlack 9016
GLAS		-
ZARGE		KR1
BESCHLAG		MONO, Graphitschwarz
MODEL		COMO CK3
FINISH		White varnish 9016
GLASS		-
FRAME		KR1
FITTINGS		MONO, Graphite black

MODELL	2	COMO CKL3+SP4
OBERFLÄCHE		Weißlack 9016
GLAS		SATINATO, Standard-Ornamentglas
ZARGE		KR1
BESCHLAG		MONO, Graphitschwarz
MODEL		COMO CKL3+SP4
FINISH		White varnish 9016
GLASS		SATINATO, standard patterned glass
FRAME		KR1
FITTINGS		MONO, Graphite black

MODELL	3	COMO CK4
OBERFLÄCHE		Weißlack 9016
GLAS		-
ZARGE		KR1
BESCHLAG		MONO, Graphitschwarz
MODEL		COMO CK4
FINISH		White varnish 9016
GLASS		-
FRAME		KR1
FITTINGS		MONO, Graphite black

MODELL	4	COMO CKL4
OBERFLÄCHE		Weißlack 9016
GLAS		SATINATO, Standard-Ornamentglas
ZARGE		KR1
BESCHLAG		MONO, Graphitschwarz
MODEL		COMO CKL4
FINISH		White varnish 9016
GLASS		SATINATO, standard patterned glass
FRAME		KR1
FITTINGS		MONO, Graphite black

MODELL	5	COMO CKL4/2
OBERFLÄCHE		Weißlack 9016
GLAS		SATINATO, Standard-Ornamentglas
ZARGE		KR1
BESCHLAG		MONO, Graphitschwarz
MODEL		COMO CKL4/2
FINISH		White varnish 9016
GLASS		SATINATO, standard patterned glass
FRAME		KR1
FITTINGS		MONO, Stainless steel matt

MODELL	6	COMO C2
OBERFLÄCHE		Weißlack 9016
GLAS		-
ZARGE		KR1
BESCHLAG		MONO, Edelstahl Matt
MODEL		COMO C2
FINISH		White varnish 9016
GLASS		-
FRAME		KR1
FITTINGS		MONO, Stainless steel matt

MODELL	7	COMO CL2
OBERFLÄCHE		Weißlack 9016
GLAS		WOOD1-DA, Design-Ornamentglas
ZARGE		KR1
BESCHLAG		MONO, Edelstahl Matt
MODEL		COMO CL2
FINISH		White varnish 9016
GLASS		WOOD1-DA, design patterned glass
FRAME		KR1
FITTINGS		MONO, Stainless steel matt



JETZT TESTEN
Im Online-Türentool „DieTÜR“ von GARANT kombinieren Sie mit einfachen Klicks Ihre individuelle Wunschtür.
TEST NOW
Use GARANT's online door tool 'DieTÜR' to create your own custom door in just a few clicks.



COMO
Weißlack 9010

Vielseitig schön
Beautiful versatility

Klassisches Weiß für eine harmonische Raumausstattung.
Classic white for a harmonious interior design concept.

BESCHLAG
NEO

GRAPHITSCHWARZ
GRAPHITE BLACK



BB/PZ/WC



smart2lock

EDELSTAHL MATT
STAINLESS STEEL MATT



BB/PZ/WC



smart2lock

QUERSCHNITT | CROSS

RUNDKANTE | ROUNDED EDGE



Lichtausschnitt-Türen



geschlossene Türen



MODELL	1	COMO CK3
OBERFLÄCHE		Weißlack 9010
GLAS		-
ZARGE		R1
BESCHLAG		NEO, Graphitschwarz
MODEL		COMO CK3
FINISH		White varnish 9010
GLASS		-
FRAME		R1
FITTINGS		NEO, Graphite black

MODELL	2	COMO CKL3+SP4
OBERFLÄCHE		Weißlack 9010
GLAS		SATINATO, Standard-Ornamentglas
ZARGE		R1
BESCHLAG		NEO, Graphitschwarz
MODEL		COMO CKL3+SP4
FINISH		White varnish 9010
GLASS		SATINATO, standard patterned glass
FRAME		R1
FITTINGS		NEO, Graphite black

MODELL	3	COMO CK4
OBERFLÄCHE		Weißlack 9010
GLAS		-
ZARGE		R1
BESCHLAG		NEO, Graphitschwarz
MODEL		COMO CK4
FINISH		White varnish 9010
GLASS		-
FRAME		R1
FITTINGS		NEO, Graphite black

MODELL	4	COMO CKL4
OBERFLÄCHE		Weißlack 9010
GLAS		SATINATO, Standard-Ornamentglas
ZARGE		R1
BESCHLAG		NEO, Graphitschwarz
MODEL		COMO CKL4
FINISH		White varnish 9010
GLASS		SATINATO, standard patterned glass
FRAME		R1
FITTINGS		NEO, Graphite black

MODELL	5	COMO CKL4/2
OBERFLÄCHE		Weißlack 9010
GLAS		SATINATO, Standard-Ornamentglas
ZARGE		R1
BESCHLAG		NEO, Edelstahl Matt
MODEL		COMO CKL4/2
FINISH		White varnish 9010
GLASS		SATINATO, standard patterned glass
FRAME		R1
FITTINGS		NEO, Stainless steel matt

MODELL	6	COMO C2
OBERFLÄCHE		Weißlack 9010
GLAS		-
ZARGE		R1
BESCHLAG		NEO, Edelstahl Matt
MODEL		COMO C2
FINISH		White varnish 9010
GLASS		-
FRAME		R1
FITTINGS		NEO, Stainless steel matt

MODELL	7	COMO CL2
OBERFLÄCHE		Weißlack 9010
GLAS		LIGNO, Design-Ornamentglas
ZARGE		R1
BESCHLAG		NEO, Edelstahl Matt
MODEL		COMO CL2
FINISH		White varnish 9010
GLASS		LIGNO, design patterned glass
FRAME		R1
FITTINGS		NEO, Stainless steel matt



JETZT TESTEN
Im Online-Türentool „DieTÜR“ von GARANT kombinieren Sie mit einfachen Klicks Ihre individuelle Wunschtür.
TEST NOW
Use GARANT's online door tool 'DieTÜR' to create your own custom door in just a few clicks.



PARMA
Weißlack 9016

PARMA
White varnish 9016

Das Leben jeden Tag genießen –
mit edlen Weißlack-PROFILTÜREN.

Enjoy life every day –
with the beautiful white varnish PROFILE DOORS.





PARMA
Weißlack 9016

Elegante Harmonie

Elegant harmony

Mit PARMA-Weißlacktüren für eine einheitlich angenehme Wohnatmosphäre sorgen.
The PARMA white varnish doors contribute to a pleasant and harmonious living environment.

QUERSCHNITT | CROSS

KLEINE RUNDKANTE | SMALL ROUNDED EDGE

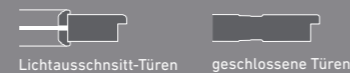

Lichtausschnitt-Türen geschlossene Türen



BESCHLAG NEO

GRAPHITSCHWARZ
GRAPHITE BLACK



BB/PZ/WC



smart2lock

EDELSTAHL MATT
STAINLESS STEEL MATT



BB/PZ/WC



smart2lock



MODELL	1 PARMA PF3
OBERFLÄCHE	Weißlack 9016
GLAS	-
ZARGE	KR1
BESCHLAG	NEO, Graphitschwarz
MODEL	PARMA PF1
FINISH	White varnish 3016
GLASS	-
FRAME	KR1
FITTINGS	NEO, Graphite black

MODELL	2 PARMA PF4
OBERFLÄCHE	Weißlack 9016
GLAS	-
ZARGE	KR1
BESCHLAG	NEO, Graphitschwarz
MODEL	PARMA PF4
FINISH	White varnish 9016
GLASS	-
FRAME	KR1
FITTINGS	NEO, Graphite black

MODELL	3 PARMA PFL4
OBERFLÄCHE	Weißlack 9016
GLAS	SATINATO, Standard-Ornamentglas
ZARGE	KR1
BESCHLAG	NEO, Graphitschwarz
MODEL	PARMA PFL4
FINISH	White varnish 9016
GLASS	SATINATO, standard patterned glass
FRAME	KR1
FITTINGS	NEO, Graphite black

MODELL	4 PARMA PFL4+SP4
OBERFLÄCHE	Weißlack 9016
GLAS	SATINATO, Standard-Ornamentglas
ZARGE	KR1
BESCHLAG	NEO, Graphitschwarz
MODEL	PARMA PFL4+SP4
FINISH	White varnish 9016
GLASS	SATINATO, standard patterned glass
FRAME	KR1
FITTINGS	NEO, Graphite black

MODELL	5 PARMA PFL4/2
OBERFLÄCHE	Weißlack 9016
GLAS	SATINATO, Standard-Ornamentglas
ZARGE	KR1
BESCHLAG	NEO, Edelstahl Matt
MODEL	PARMA PFL4/2
FINISH	White varnish 9016
GLASS	SATINATO, standard patterned glass
FRAME	KR1
FITTINGS	NEO, Stainless steel matt

MODELL	6 PARMA PF5
OBERFLÄCHE	Weißlack 9016
GLAS	-
ZARGE	KR1
BESCHLAG	NEO, Edelstahl Matt
MODEL	PARMA PFL5
FINISH	White varnish 9016
GLASS	-
FRAME	KR1
FITTINGS	NEO, Stainless steel matt

MODELL	7 PARMA PFL5
OBERFLÄCHE	Weißlack 9016
GLAS	WOOD1-DQ, Design-Ornamentglas
ZARGE	KR1
BESCHLAG	NEO, Edelstahl Matt
MODEL	PARMA PFL5
FINISH	White varnish 9016
GLASS	WOOD1-DQ, design patterned glass
FRAME	KR1
FITTINGS	NEO, Stainless steel matt



JETZT TESTEN
Im Online-Türentool „DieTÜR“ von GARANT kombinieren Sie mit einfachen Klicks Ihre individuelle Wunschtür.
TEST NOW
Use GARANT's online door tool "DieTÜR" to create your own custom door in just a few clicks.

PARMA
Weißlack 9010

Lebensfreude pur
Pure joie de vivre

Ein Genuss: Die perfekten Türen für jeden Wohnraum.
These doors are perfect for any living space and a pleasure to see.

QUERSCHNITT | CROSS

RUNDKANTE | ROUNDED EDGE



BESCHLAG
CUBO

GRAPHITSCHWARZ
GRAPHITE BLACK



BB/PZ/WC



smart2lock

EDELSTAHL MATT
STAINLESS STEEL MATT



BB/PZ/WC



smart2lock



MODELL
OBERFLÄCHE
GLAS
ZARGE
BESCHLAG
MODEL
FINISH
GLASS
FRAME
FITTINGS

1 PARMA PF3
Weißlack 9010
-
R1
CUBO, Graphitschwarz
PARMA PF3
White varnish 9010
-
R1
CUBO, Graphite black

2 PARMA PF4
Weißlack 9010
-
R1
CUBO, Graphitschwarz
PARMA PF4
White varnish 9010
-
R1
CUBO, Graphite black

3 PARMA PFL4
Weißlack 9010
SATINATO, Standard-Ornamentglas
R1
CUBO, Graphitschwarz
PARMA PFL4
White varnish 9010
SATINATO, standard patterned glass
R1
CUBO, Graphite black

4 PARMA PFL4+SP4
Weißlack 9010
SATINATO, Standard-Ornamentglas
R1
CUBO, Graphitschwarz
PARMA PFL+SP4
White varnish 9010
SATINATO, standard patterned glass
R1
CUBO, Graphite black

5 PARMA PFL4/2
Weißlack 9010
SATINATO, Standard-Ornamentglas
R1
CUBO, Edelstahl Matt
PARMA PFL4/2
White varnish 9010
SATINATO, standard patterned glass
R1
CUBO, Stainless steel matt

6 PARMA PF5
Weißlack 9010
-
R1
CUBO, Edelstahl Matt
PARMA PF5
White varnish 9010
-
R1
CUBO, Stainless steel matt

7 PARMA PFL5
Weißlack 9010
PANNO, Design-Ornamentglas
R1
CUBO, Edelstahl Matt
PARMA PFL5
White varnish 9010
PANNO, design patterned glass
R1
CUBO, Stainless steel matt



JETZT TESTEN
Im Online-Türentool „DieTÜR“ von GARANT kombinieren Sie mit einfachen Klicks Ihre individuelle Wunschtür.
TEST NOW
Use GARANT's online door tool 'DieTÜR' to create your own custom door in just a few clicks.

Gesamtübersicht PROFILTÜREN-Programm

Overview of the PROFILE DOOR range

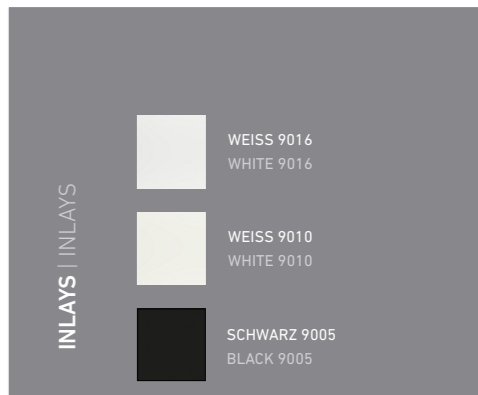
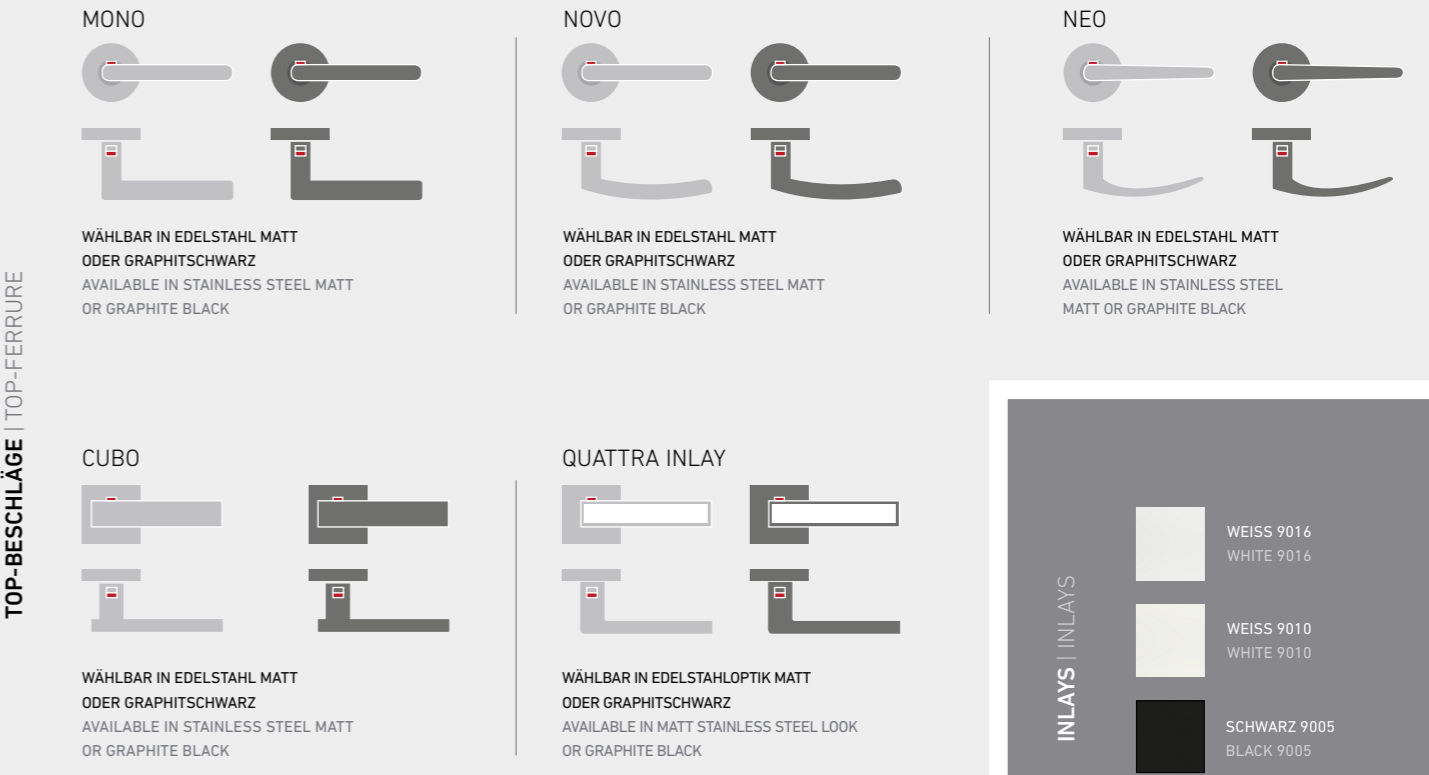
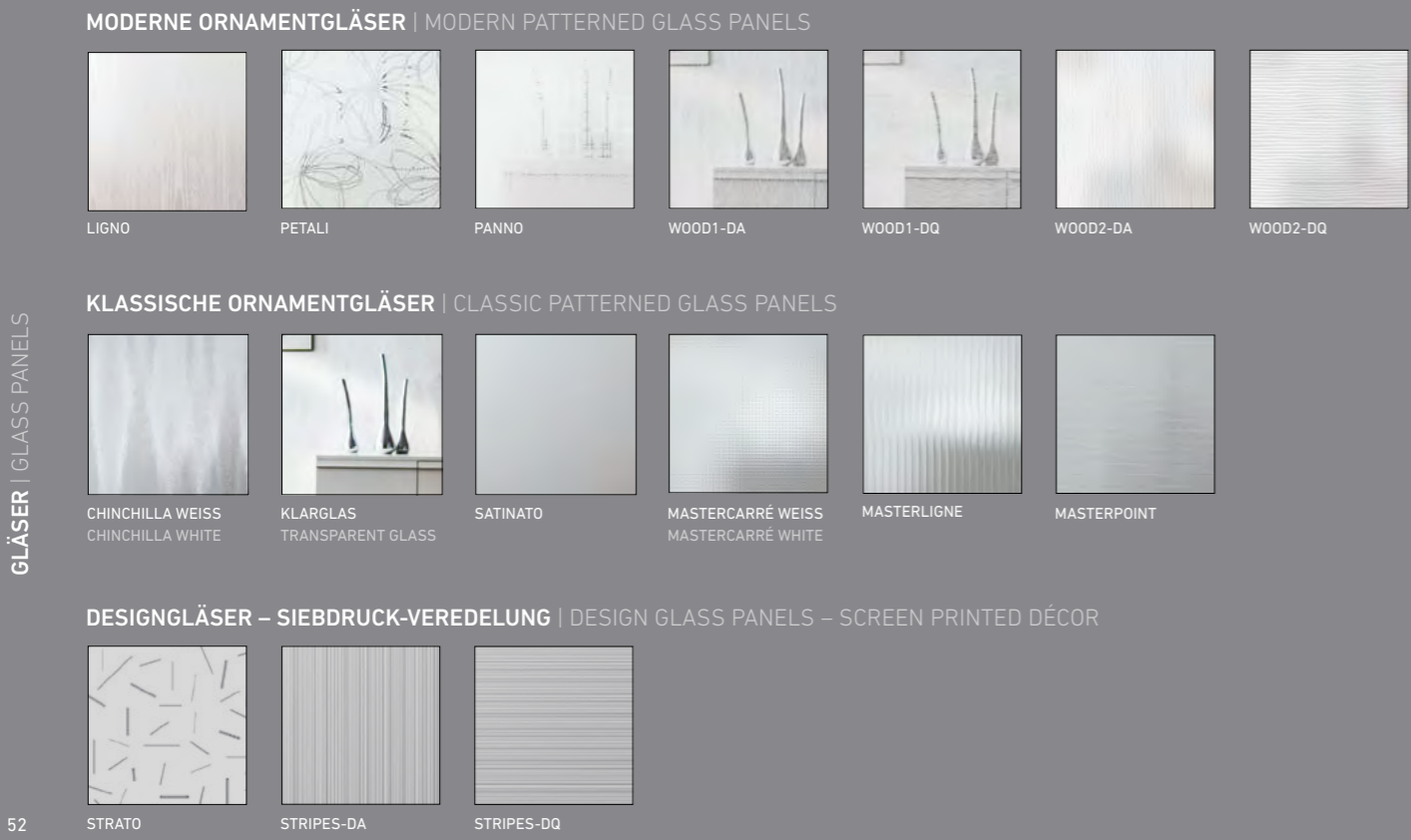
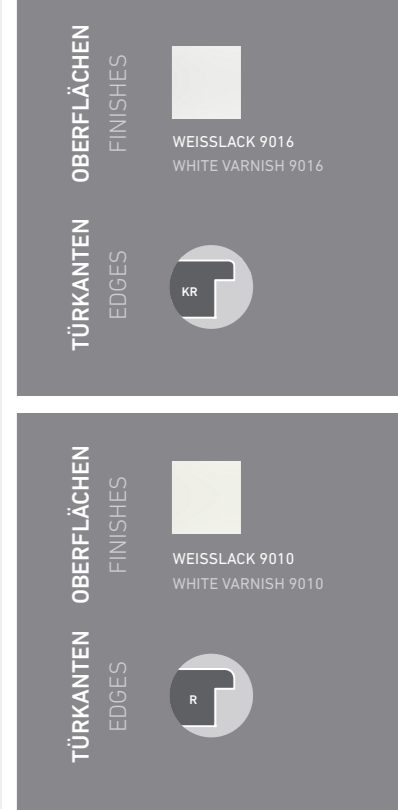
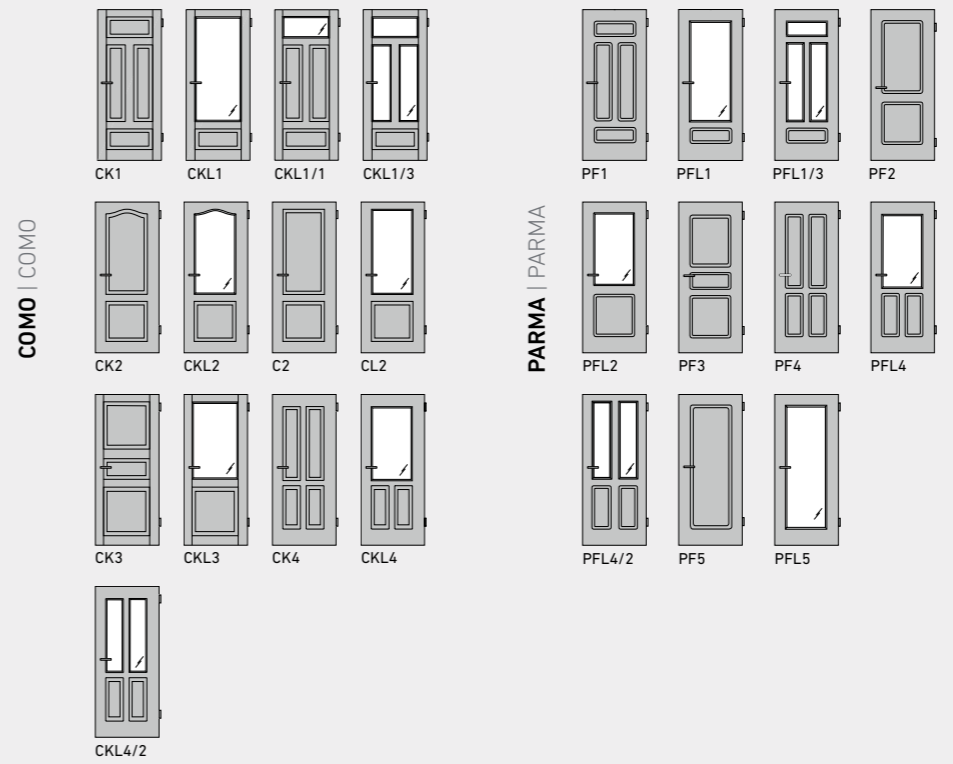
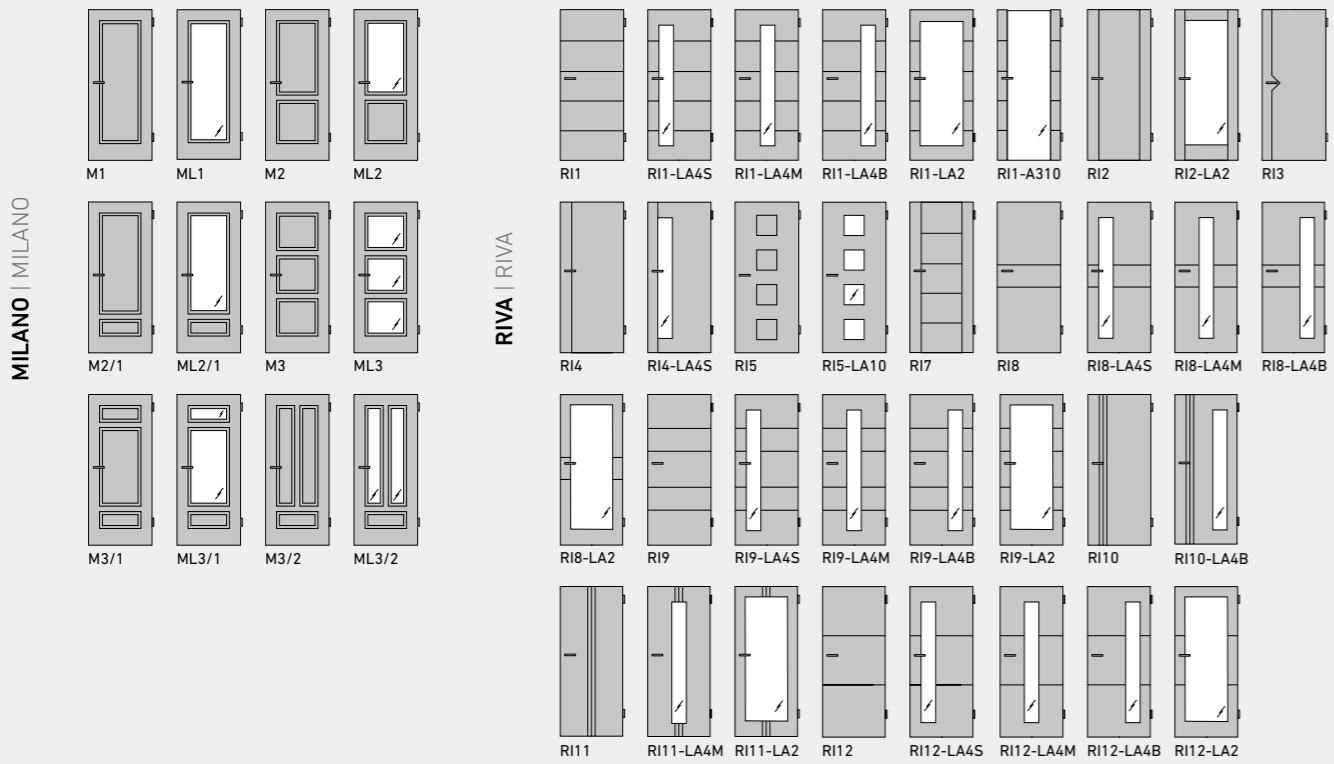

Das STILTÜREN-Programm

The STYLISTIC DOOR range

KLASSISCH-MODERNE TÜREN, DIE RUHE AUSSTRAHLEN

Unsere STILTÜREN in zeitloser Optik passen zu jedem Wohnstil.

CLASSIC, MODERN DOORS THAT EXUDE A SENSE OF CALM

Our STYLE DOORS have timeless appeal that harmonises with any style of interior design.





AMRUM
Weißlack 9016

AMRUM
White varnish 9016

Offen für Harmonie und immer stilvoll:
unsere klassischen Weißlacktüren.

Always harmonious, always elegant:
our classic white varnish doors.





AMRUM
Weißlack 9016

Stilvolle Einblicke Stylish perspectives

Ein hochwertiges Erscheinungsbild und Glasdetails nach Wahl werten jeden Raum auf.
A elegant look combined with optional glass details enhances any room.

QUERSCHNITT | CROSS

KLEINE RUNDKANTE | SMALL ROUNDED EDGE

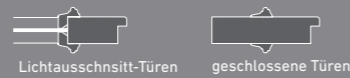

BESCHLAG
NOVO

GRAPHITSCHWARZ
GRAPHITE BLACK



BB/PZ/WC



smart2lock

EDELSTAHL MATT
STAINLESS STEEL MATT



BB/PZ/WC



smart2lock



MODELL	1 AMRUM AS2
OBERFLÄCHE	Weißlack 9016
GLAS	-
ZARGE	KR1
BESCHLAG	NOVO, Graphitschwarz
MODEL	AMRUM AS2
FINISH	White varnish 9016
GLASS	-
FRAME	KR1
FITTINGS	MONO, Graphite black

MODELL	2 AMRUM ASL2
OBERFLÄCHE	Weißlack 9016
GLAS	SATINATO, Standard-Ornamentglas
ZARGE	KR1
BESCHLAG	NOVO, Graphitschwarz
MODEL	AMRUM ASL2
FINISH	White varnish 9016
GLASS	SATINATO, standard patterned glass
FRAME	KR1
FITTINGS	MONO, Graphite black

MODELL	3 AMRUM AM1
OBERFLÄCHE	Weißlack 9016
GLAS	-
ZARGE	KR1
BESCHLAG	NOVO, Graphitschwarz
MODEL	AMRUM AM1
FINISH	White varnish 9016
GLASS	-
FRAME	KR1
FITTINGS	MONO, Graphite black

MODELL	4 AMRUM AML1
OBERFLÄCHE	Weißlack 9016
GLAS	SATINATO, Standard-Ornamentglas
ZARGE	KR1
BESCHLAG	NOVO, Graphitschwarz
MODEL	AMRUM AML1
FINISH	White varnish 9016
GLASS	SATINATO, standard patterned glass
FRAME	KR1
FITTINGS	MONO, Graphite black

MODELL	5 AMRUM AML1/3
OBERFLÄCHE	Weißlack 9016
GLAS	SATINATO, Standard-Ornamentglas
ZARGE	KR1
BESCHLAG	NOVO, Edelstahl Matt
MODEL	AMRUM AML1/3
FINISH	White varnish 9016
GLASS	SATINATO, standard patterned glass
FRAME	KR1
FITTINGS	NOVO, Stainless steel matt

MODELL	6 AMRUM AM5
OBERFLÄCHE	Weißlack 9016
GLAS	-
ZARGE	KR1
BESCHLAG	NOVO, Edelstahl Matt
MODEL	AMRUM AM5
FINISH	White varnish 9016
GLASS	-
FRAME	KR1
FITTINGS	NOVO, Stainless steel matt

MODELL	7 AMRUM AML5
OBERFLÄCHE	Weißlack 9016
GLAS	WOOD1-DQ, Design-Ornamentglas
ZARGE	KR1
BESCHLAG	NOVO, Edelstahl Matt
MODEL	AMRUM AML5
FINISH	White varnish 9016
GLASS	WOOD1-DQ, design patterned glass
FRAME	KR1
FITTINGS	NOVO, Stainless steel matt



JETZT TESTEN
Im Online-Türentool „DieTÜR“ von GARANT kombinieren Sie mit einfachen Klicks Ihre individuelle Wunschtür.
TEST NOW
Use GARANT's online door tool 'DieTÜR' to create your own custom door in just a few clicks.



AMRUM
Weißlack 9010

Stilbewusstsein beweisen Superior elegance

Mit unseren Weißlacktüren in zeitlos-moderner Kassettenoptik.
With our white varnish doors in a timeless, modern panelled look.

QUERSCHNITT | CROSS

RUNDKANTE | ROUNDED EDGE

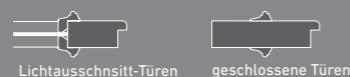

Lichtausschnitt-Türen

geschlossene Türen



BESCHLAG MONO

GRAPHITSCHWARZ
GRAPHITE BLACK



BB/PZ/WC



smart2lock

EDELSTAHL MATT
STAINLESS STEEL MATT



BB/PZ/WC



smart2lock



MODELL	1 AMRUM AS2
OBERFLÄCHE	Weißlack 9010
GLAS	-
ZARGE	R1
BESCHLAG	MONO, Graphitschwarz
MODEL	AMRUM AS2
FINISH	White varnish 9010
GLASS	-
FRAME	R1
FITTINGS	MONO, Graphite black

MODELL	2 AMRUM ASL2
OBERFLÄCHE	Weißlack 9010
GLAS	SATINATO, Standard-Ornamentglas
ZARGE	R1
BESCHLAG	MONO, Graphitschwarz
MODEL	AMRUM ASL2
FINISH	White varnish 9010
GLASS	SATINATO, standard patterned glass
FRAME	R1
FITTINGS	MONO, Graphite black

MODELL	3 AMRUM AM1
OBERFLÄCHE	Weißlack 9010
GLAS	-
ZARGE	R1
BESCHLAG	MONO, Graphitschwarz
MODEL	AMRUM AM1
FINISH	White varnish 9010
GLASS	-
FRAME	R1
FITTINGS	MONO, Graphite black

MODELL	4 AMRUM AML1
OBERFLÄCHE	Weißlack 9010
GLAS	SATINATO, Standard-Ornamentglas
ZARGE	R1
BESCHLAG	MONO, Graphitschwarz
MODEL	AMRUM AML1
FINISH	White varnish 9010
GLASS	SATINATO, standard patterned glass
FRAME	R1
FITTINGS	MONO, Graphite black

MODELL	5 AMRUM AML1/3
OBERFLÄCHE	Weißlack 9010
GLAS	SATINATO, Standard-Ornamentglas
ZARGE	R1
BESCHLAG	MONO, Edelstahl Matt
MODEL	AMRUM AML1/3
FINISH	White varnish 9010
GLASS	SATINATO, standard patterned glass
FRAME	R1
FITTINGS	MONO, Stainless steel matt

MODELL	6 AMRUM AM5
OBERFLÄCHE	Weißlack 9010
GLAS	-
ZARGE	R1
BESCHLAG	MONO, Edelstahl Matt
MODEL	AMRUM AM5
FINISH	White varnish 9010
GLASS	-
FRAME	R1
FITTINGS	MONO, Stainless steel matt

MODELL	7 AMRUM AML5
OBERFLÄCHE	Weißlack 9010
GLAS	PETALI, Design-Ornamentglas
ZARGE	R1
BESCHLAG	MONO, Edelstahl Matt
MODEL	AMRUM AML5
FINISH	White varnish 9010
GLASS	PETALI, design patterned glass
FRAME	R1
FITTINGS	MONO, Stainless steel matt



JETZT TESTEN
Im Online-Türentool „DieTÜR“ von GARANT kombinieren Sie mit einfachen Klicks Ihre individuelle Wunschtür.
TEST NOW
Use GARANT's online door tool "DieTÜR" to create your own custom door in just a few clicks.

Gesamtübersicht STILTÜREN-Programm

Overview of the STYLISTIC DOOR range

AMRUM | AMRUM

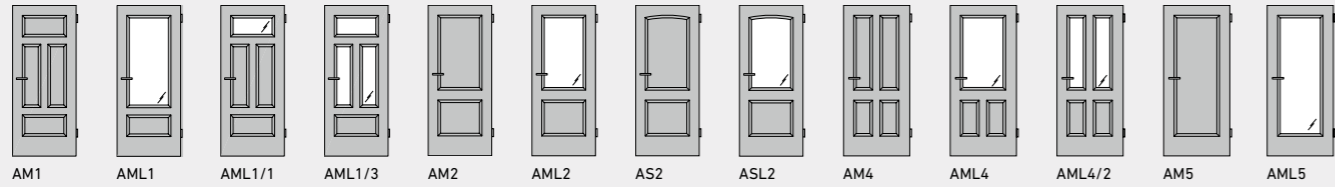

OBERFLÄCHEN
FINISHES

WEISSLACK 9016
WHITE VARNISH 9016

OBERFLÄCHEN
FINISHES

WEISSLACK 9010
WHITE VARNISH 9010

TÜRKANTEN
EDGES



TÜRKANTEN
EDGES



MODERNE ORNAMENTGLÄSER | MODERN PATTERNED GLASS PANELS

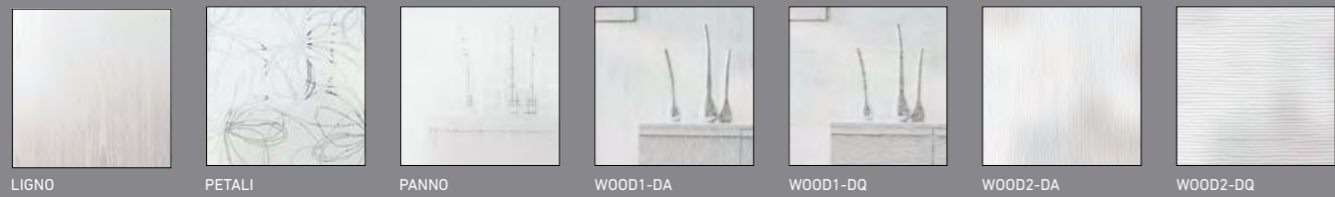

DESIGNGLÄSER – SIEBDRUCK-VEREDELUNG | DESIGN GLASS PANELS – SCREEN PRINTED DÉCOR

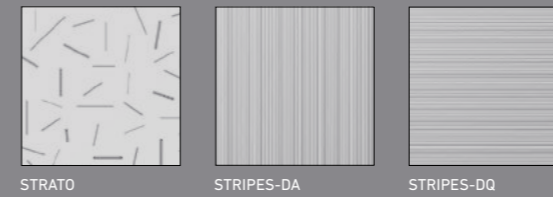

GLÄSER | GLASS PANELS

KLASSISCHE ORNAMENTGLÄSER | CLASSIC PATTERNED GLASS PANELS



TOP-BESCHLÄGE | TOP-FERRURE

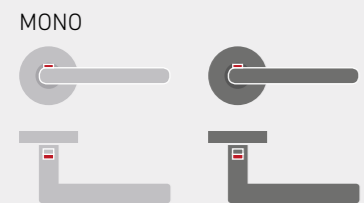

WÄHLBAR IN EDELSTAHL MATT ODER GRAPHITSCHWARZ
AVAILABLE IN STAINLESS STEEL MATT OR GRAPHITE BLACK

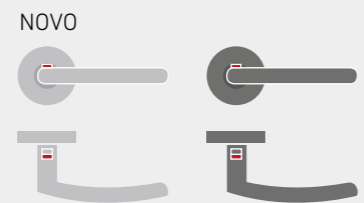

WÄHLBAR IN EDELSTAHL MATT ODER GRAPHITSCHWARZ
AVAILABLE IN STAINLESS STEEL MATT OR GRAPHITE BLACK

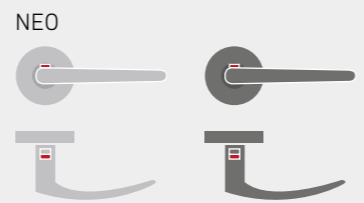

WÄHLBAR IN EDELSTAHL MATT ODER GRAPHITSCHWARZ
AVAILABLE IN STAINLESS STEEL MATT OR GRAPHITE BLACK

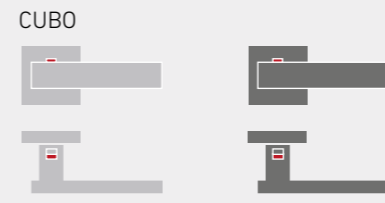

WÄHLBAR IN EDELSTAHL MATT ODER GRAPHITSCHWARZ
AVAILABLE IN STAINLESS STEEL MATT OR GRAPHITE BLACK

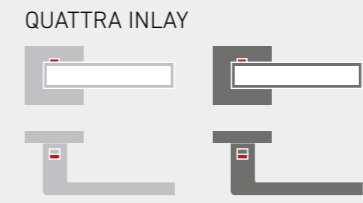

WÄHLBAR IN EDELSTAHOPTIK MATT ODER GRAPHITSCHWARZ
AVAILABLE IN MATT STAINLESS STEEL LOOK OR GRAPHITE BLACK

INLAYS | INLAYS



Elemente

Elements

Beim Thema Türen sind wir in unserem Element und können Ihnen mit Sicherheit immer die richtigen Türelemente bieten. Unsere durchdachten Lösungen ermöglichen Ihnen die Umsetzung Ihrer individuellen Raumkonzepte.

We're in our element when it comes to the subject of doors, and we guarantee we can always provide you with the perfect door elements. Our clever solutions enable you to realise your personal interior design concepts.



WINDFANGELEMENTE UND SCHIEBETÜRLÖSUNGEN



DOPPELTÜREN (2-FLG. TÜREN)



GESCHOSSHOHE ELEMENTE



SCHÖN FÜR DIE OPTIK, PRAKTISCH FÜR ALLTÄGLICHE SITUATIONEN

Mit unseren geschosshohen Elementen sorgen Sie für eine großzügige Türen-Optik und nutzen Ihre Raumhöhe optimal aus.

BEAUTIFUL TO LOOK AT; PRACTICAL IN EVERYDAY USE.

Our ceiling-height elements give the door a generously-dimensioned appearance and make optimum use of the room height.

VIDEO Geschosshohe Elemente | Ceiling-height elements [KLICK](#)



Beschlag mit PZ-Schloss



Ganzglastür mit Ganzglas-Oberlicht



Magnet-Schließblech



Stumpfes Türelement mit Oberblende



Stumpfes Türelement mit Oberlicht



Geschosshohe Elemente
Ceiling-height elements

Schön und praktisch | Beautiful and practical



Windfangelemente und Schiebetürlösungen Draught-stop elements and sliding doors



SCHIEBETÜRBESCHLAG LINE

Das schlanke Schiebetürsystem im Edelstahl-Design für Holz- und Ganzglastüren. LINE ist wahlweise auch mit Einzugsdämpfung (beidseitig) lieferbar.

LINE SLIDING DOOR FITTING

The streamlined sliding door system in a stainless steel design for wood and all-glass doors is also available with an optional soft close function (both sides).



SCHIEBETÜRBESCHLAG BASIC – AUSFÜHRUNG „VOR DER WAND LAUFEND“

Die gehobene Holzklasse, unser BASIC-Schiebetürbeschlag für Holz- und Ganzglastüren. Öffnen Sie Türen auf die klassische Art. BASIC ist wahlweise auch mit Einzugsdämpfung (ein- oder beidseitig) lieferbar.

BASIC SLIDING DOOR FITTING – ‘FRONT OF WALL’ VERSION

Our BASIC sliding door fittings for wood and all-glass doors are premium hardware. Open the doors in the conventional way. BASIC is also available with an optional soft close function (one or both sides).

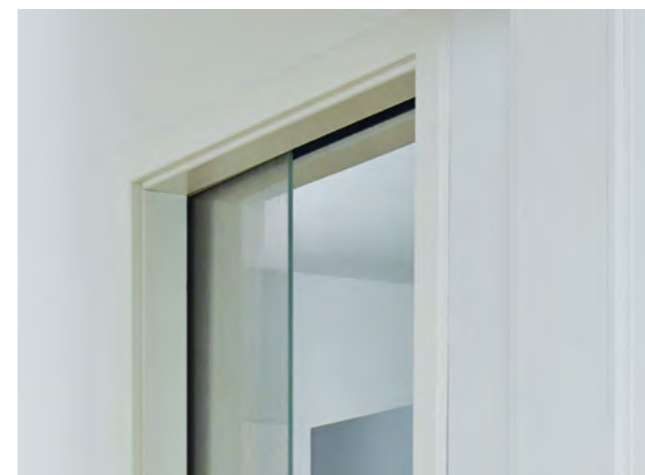

SCHIEBETÜRBESCHLAG BASIC – AUSFÜHRUNG „IN DER WAND LAUFEND“

Innenlaufende Schiebetüren mit dem BASIC-Schiebetürbeschlag – egal ob als Holz- oder Ganzglastüren – sind die ideale Lösung, wenn es für normale Drehtüren in den verbundenen Räumen keinen Öffnungs- und Bewegungsraum gibt.

BASIC SLIDING DOOR FITTINGS – ‘IN-WALL’ VERSION

In-wall sliding doors – both wood and glass models – with BASIC sliding door fittings are the ideal solution when there is no space for conventionally opening doors in connected rooms.



Windfangelemente und Schiebetürlösungen

Schiebetürbeschlag LINE

LINE sliding door fittings

Platzsparendes Design auch für kleine Räume.
Space-saving design for small rooms.



SCHIEBETÜRBESCHLAG LINE

Das schlanke Schiebetürsystem im Edelstahl-Design für Holz- und Ganzglastüren. LINE ist wahlweise auch mit Einzugsdämpfung (beidseitig) lieferbar.

LINE SLIDING DOOR FITTINGS

The streamlined sliding door system in a stainless steel design for wood and all-glass doors is also available with an optional soft close function (both sides).

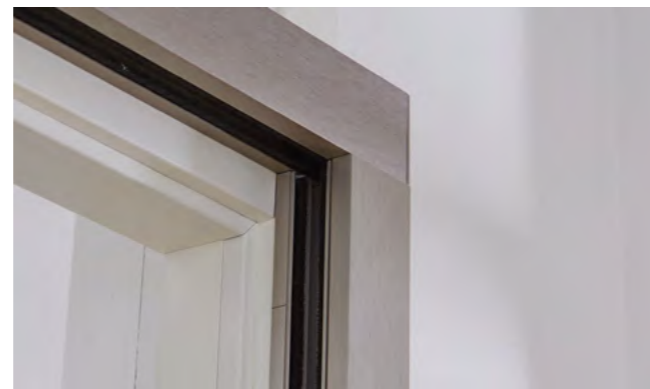

LINE mit Anschlagkasten



Befestigung einer Holztür im Schiebetürbeschlag LINE

LINE-Schiebetürbeschlag mit Inlay

LINE sliding door fitting with inlay

VIDEO Windfangelemente und Schiebetürlösungen
Draught-stop elements and sliding doors

[KLICK](#)



In diesen Oberflächen erhältlich | Available in these finishes



WEISS 9016
WHITE 9016



WEISS 9010
WHITE 9010



SCHWARZ 9005
BLACK 9005



Befestigung einer Ganzglastür im Schiebetürbeschlag LINE



LINE ohne Anschlagkasten

Schiebetürbeschlag BASIC – vor der Wand laufend BASIC sliding door fitting – ‘front of wall’ version



BASIC mit Anschlagkasten



BASIC ohne Anschlagkasten

Die klassische Variante für Schiebetüren: Der obere Laufkasten – farb- und dekor- gleich zur verwendeten Zarge – versteckt gekonnt den Schiebemechanismus. Mit dem vorderen Anschlagkasten wird der optionale Einsatz eines Schlosses möglich.

The classic version for sliding doors: The top casing is identical in colour and décor to the door frame to cleverly hide the sliding mechanism. A lock can be optionally used in conjunction with the front rabbet.



Schiebetürbeschlag BASIC – in der Wand laufend BASIC sliding door fitting – ‘in-wall’ version

SCHIEBETÜRBESCHLAG BASIC – AUSFÜHRUNG „IN DER WAND LAUFEND“ FÜR GANZGLASTÜREN

Innenlaufende Schiebetürelemente mit dem BASIC-Schiebetürbeschlag für Ganzglastüren sind die ideale Lösung, wenn es für herkömmliche Ganzglastüren als Drehtüren in den verbundenen Räumen keinen Öffnungs- und Bewegungsraum gibt.

BASIC SLIDING DOOR FITTING – ‘IN WALL’ VERSION FOR ALL-GLASS DOORS

In-wall sliding door elements with the BASIC sliding door fittings for all-glass doors are the ideal solution when there is no space for conventionally opening doors in connected rooms.

SCHIEBETÜRBESCHLAG BASIC – AUSFÜHRUNG „IN DER WAND LAUFEND“ FÜR HOLZTÜREN

Innenlaufende Schiebetürelemente mit dem BASIC-Schiebetürbeschlag für Holztüren sind die ideale Lösung, wenn es keinen Platz für herkömmliche Drehtürsysteme gibt.

BASIC SLIDING DOOR FITTINGS – ‘IN-WALL’ VERSION FOR WOODEN DOORS

In-wall sliding door elements with the BASIC fittings for wooden doors are the ideal solution when there is no deal solution when there is no space for conventionally opening doors.





VERDOPPELN SIE IHRE MÖGLICHKEITEN

Mit unseren 2-flügeligen Türen sorgen Sie für mehr Großzügigkeit, Offenheit und Licht. So kommen Ihre Räume ganz groß heraus.

DOUBLE YOUR POSSIBILITIES

With our double-leaf doors you get more space, openness and light. They help you to maximise your room space.



MILANO ML1, 2-flügelig, Verglasung PANNO



NT-DA, 2-flügelig



GANZGLAS-Tür 2-flügelig in Windfang-Zarge, Seitenteilverglasung KLARGLAS, Verglasung Tür Design RI1.1, Weißlack 9010



Doppeltüren (2-flg.) | Double-leaf doors

Großzügigkeit mal 2 | Twice the size

Technische Details

Technical details

ENTDECKEN SIE UNSERE TÜRENDETAILS AUF EINEN BLICK

Eine Übersicht über Glasprogramm, Beschläge, Zargen und spezielle Funktionen.

ALL THE DETAILS ABOUT OUR DOORS AT A GLANCE

An overview of the glass range, fittings, frames and special functions.

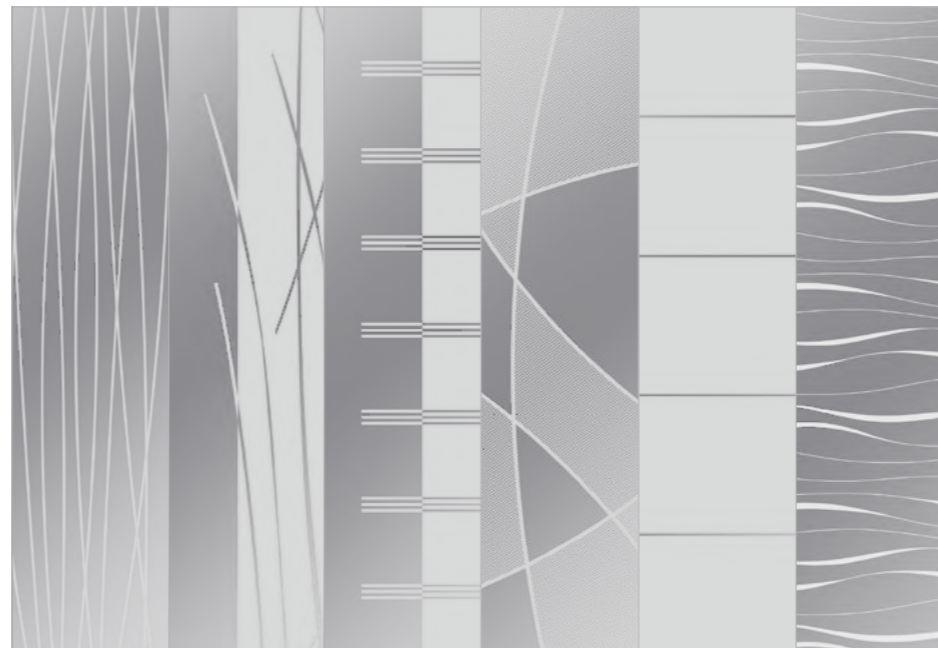
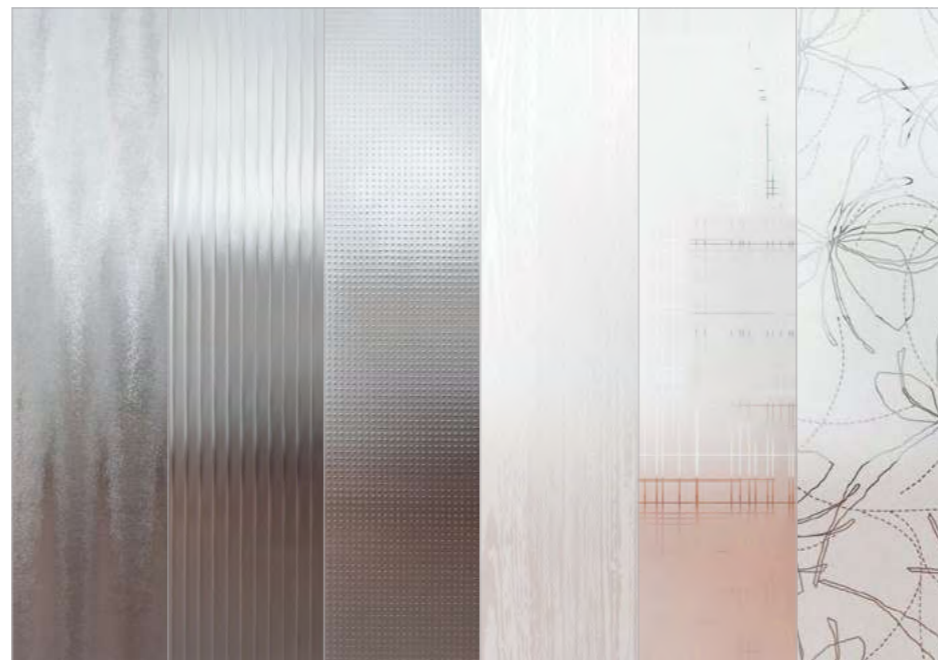

GARANT-DESIGNVERBUND
Ornamentgläser als Ganzglastür
und Lichtausschnittgläser erhältlich.

GARANT DESIGN COMPOSITION
Patterned glass is available for
doors and door panels.

Ornamentglas für Ganzglastüren

Patterned glass for all-glass doors

Moderne Ganzglastüren für raffinierte Lichtblicke.

Modern all-glass doors are a clever way to make rooms lighter.

DESIGN-ORNAMENTGLAS | DESIGN PATTERNED GLASS



WOOD1-DA



WOOD1-DQ



WOOD2-DA



WOOD2-DQ



LIGNO



PETALI



PANNO

STANDARD-ORNAMENTGLAS | STANDARD PATTERNED GLASS



CHINCHILLA WEISS
CHINCHILLA WHITE



MASTERLIGNÈ



MASTERPOINT



MASTERCARRÉ



KLARGLAS
TRANSPARENT GLASS



SATINATO

GARANT-DESIGNVERBUND
Ornamentgläser als Ganzglastür
und Lichtausschnittgläser erhältlich.

GARANT DESIGN COMPOSITION
Patterned glass is available for
doors and door panels.

Ornamentglas für Lichtausschnitt-Türen

Patterned glass for doors with panels

Wählen Sie Transparenz.
Choose transparency.

DESIGN-ORNAMENTGLAS | DESIGN PATTERNED GLASS

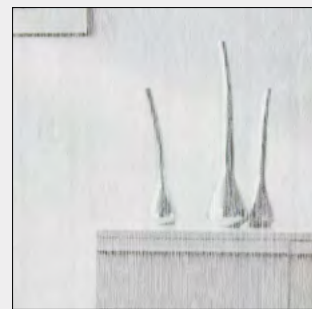

WOOD1-DA

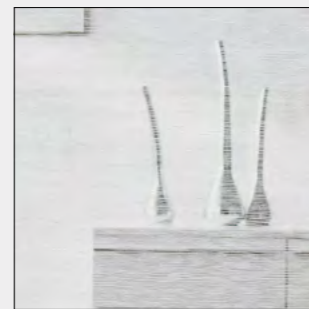

WOOD1-DQ

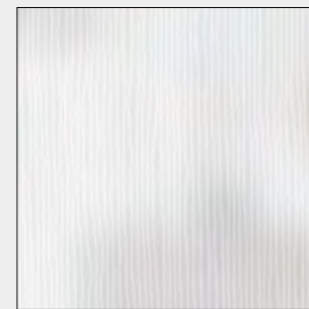

WOOD2-DA



WOOD2-DQ

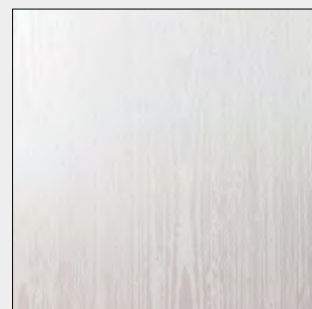

LIGNO



PETALI

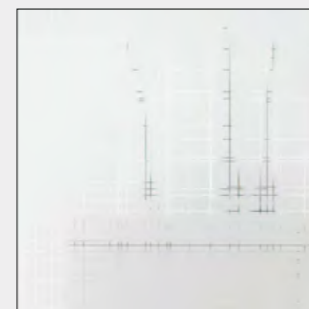

PANNO

STANDARD-ORNAMENTGLAS | STANDARD PATTERNED GLASS



CHINCHILLA WEISS
CHINCHILLA WHITE

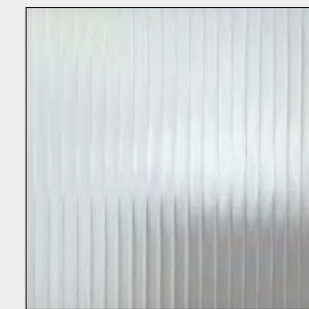

MASTERLIGNÈ

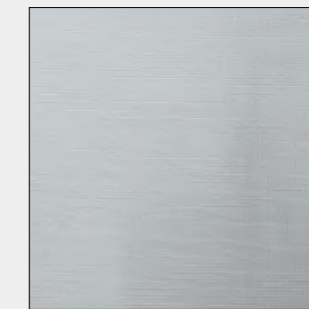

MASTERPOINT



MASTERCARRÉ

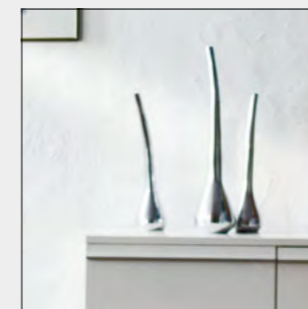

KLARGLAS
TRANSPARENT GLASS

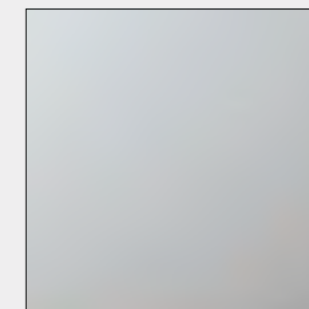

SATINATO

GARANT-DESIGNVERBUND
 Designglas motive als Ganzglastür
 und Lichtausschnittgläser erhältlich.

GARANT DESIGN COMPOSITION
 Design glass motifs are available
 for all-glass doors and door panels.

Designglas für Ganzglastüren

Design patterned glass for all-glass doors

Transparenz mit edlem Charakter.
 Elegant transparency.

SIEBDRUCK-VEREDELUNG | SCREEN PRINTED DÉCOR



LINEUM



LINUS



SEVENTY



BAMBUS



FREE



LIPSO



DESIGN R11.1



DESIGN R11.2



DESIGN R14.1



DESIGN R18.1



DESIGN R110.1

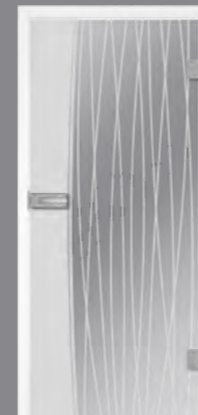

ACCORDIA



DESIGN R111.1

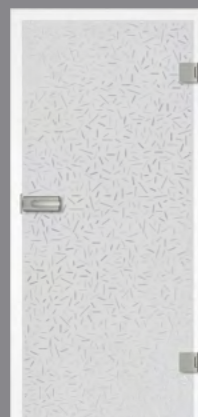

STRATO



STRIPES DA



STRIPES DQ

LASER-VEREDELUNG | LASER DÉCOR



ARPA



PALLA



FIORE



SAGI



ONDA 1



ONDA 2



MOTUS



FLORA 1



FLORA 2



CENTRO



LINEA 1

Designglas für Lichtausschnitt-Türen

Design patterned glass for doors with panels

Weil ich einzigartigen Durchblick will.
 Because I want unique vision.

SIEBDRUCK-VEREDELUNG | SCREEN PRINTED DÉCOR



LINEUM



LINUS



SEVENTY



BAMBUS



FREE

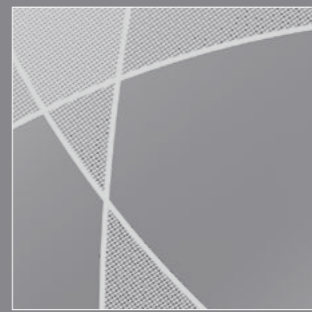

LIPSO

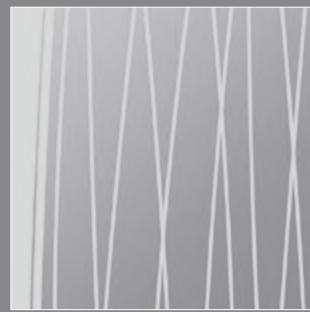

ACCORDIA



LINEA 1

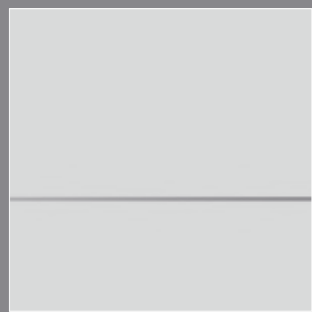

DESIGN RI1.1

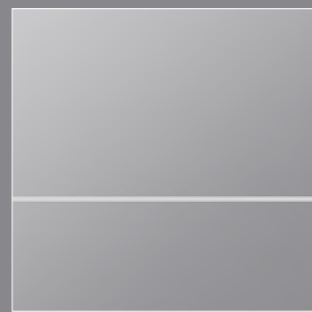

DESIGN RI1.2



STRATO



STRIPES DA/DQ

LASER-VEREDELUNG | LASER DÉCOR



ARPA

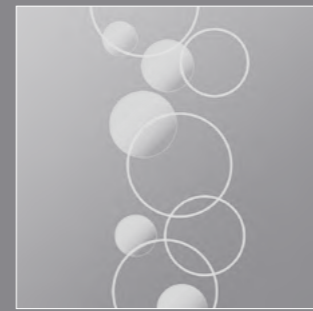

PALLA



FIORE

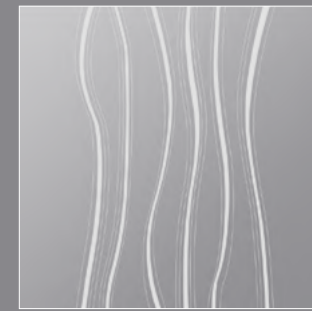

SAGI

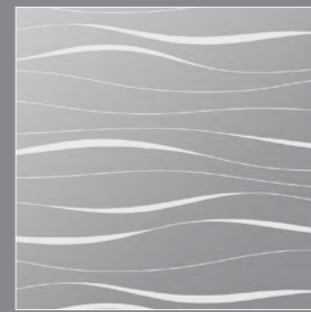

ONDA 1



ONDA 2



MOTUS

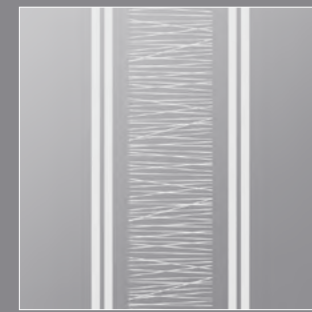

CENTRO



FLORA 1



FLORA 2

TOP

STYLE

PREMIUM

Beschlagsvielfalt in Stil und System Diverse fitting styles and systems

TÜRGRIFFE UND ZUBEHÖR FÜR ALLE ANWENDUNGEN

Türbeschläge sind ein prägendes Stilelement der Tür und unterstreichen die architektonische Note des Raums. Unser umfassendes Sortiment bietet eine Vielzahl an Designs und für jede Anforderung die passende Lösung: vom Türgriff, über das Glastürschloss bis hin zu passenden Bändern.

DOOR HANDLES AND ACCESSORIES FOR ALL APPLICATIONS

Door handles are distinctive elements of the door. They make a style statement and underline the room's architectural tone. We offer a comprehensive range of designs and the perfect solutions for all requirements: from door handles to glass door locks and matching hinges.



TOP MONO







GARANT

Griffwerk

TOP

MONO

 <p>MONO BB Schnellmontagetechnik Graphitschwarz Quick mounting mechanism Graphite black</p>	 <p>MONO BB Schnellmontagetechnik Edelstahl matt Quick mounting mechanism Matte stainless steel</p>
 <p>smart2lock by GRIFFWERK</p> <p>MONO Schnellmontagetechnik Graphitschwarz Quick mounting mechanism Graphite black</p>	 <p>smart2lock by GRIFFWERK</p> <p>MONO Schnellmontagetechnik Edelstahl matt Quick mounting mechanism Matte stainless steel</p>
 <p>MONO GGT Glastürbeschlag PURISTO S Graphitschwarz Glass door fittings Graphite black</p>	 <p>MONO GGT Glastürbeschlag PURISTO S Edelstahl matt Glass door fittings Matte stainless steel</p>
 <p>smart2lock by GRIFFWERK</p> <p>MONO GGT Glastürbeschlag PURISTO S Graphitschwarz Glass door fittings Graphite black</p>	 <p>smart2lock by GRIFFWERK</p> <p>MONO GGT Glastürbeschlag PURISTO S Edelstahl matt Glass door fittings Matte stainless steel</p>

TOP

NOVO

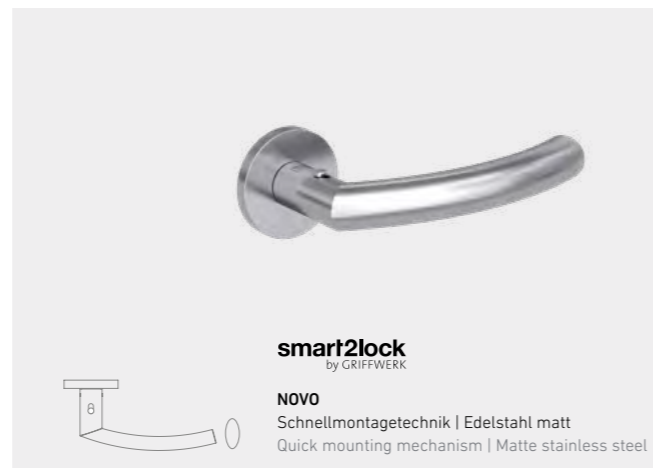
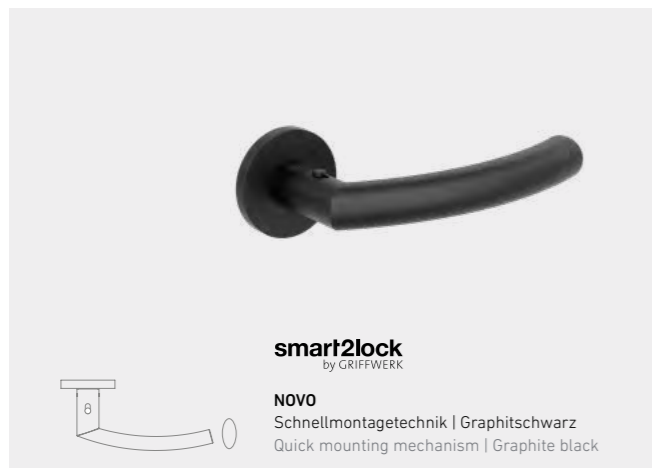
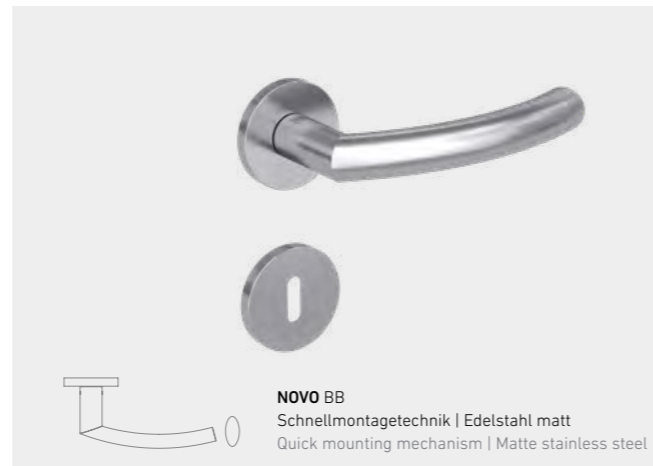
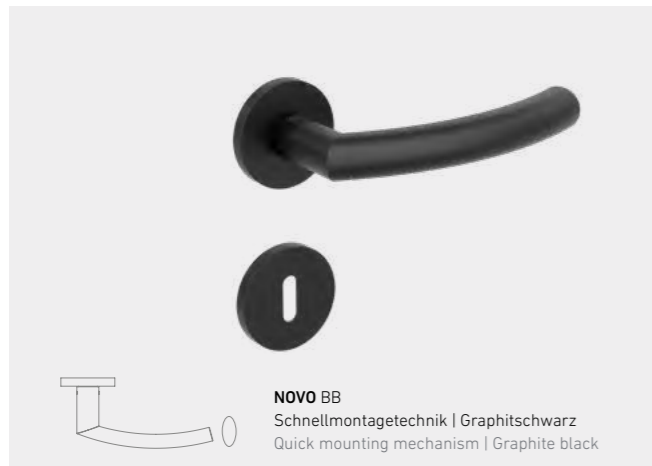

TOP

NEO

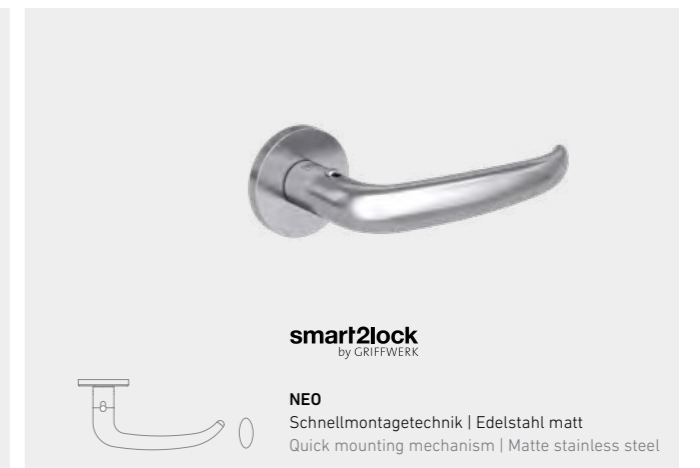

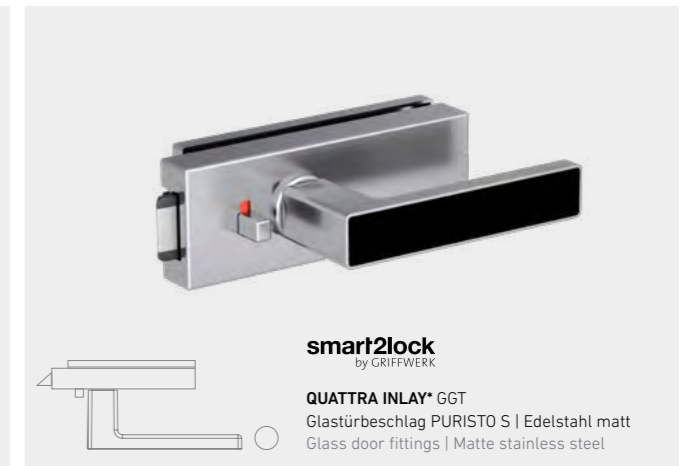
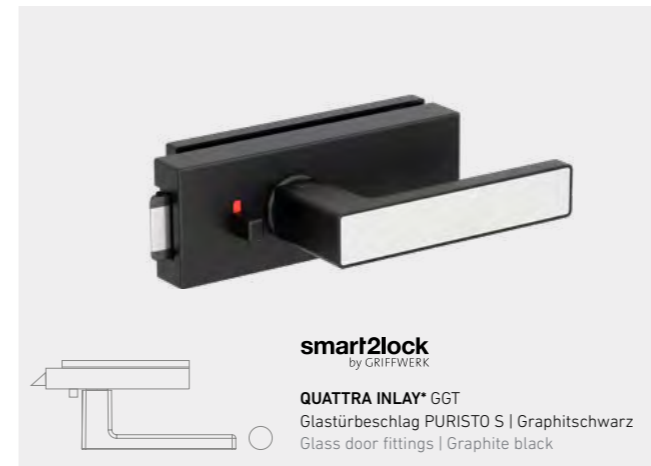
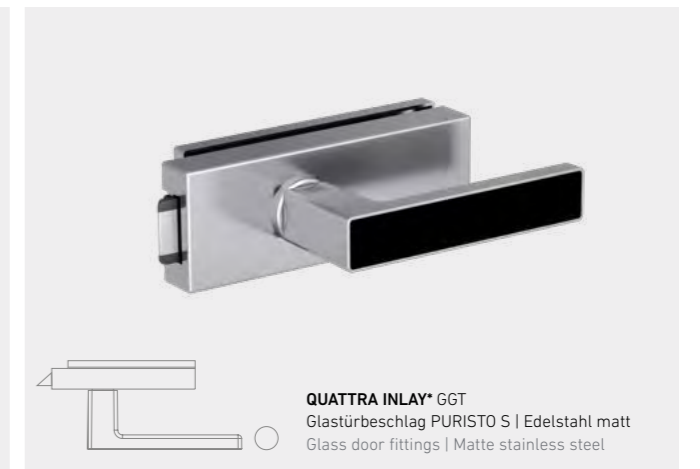
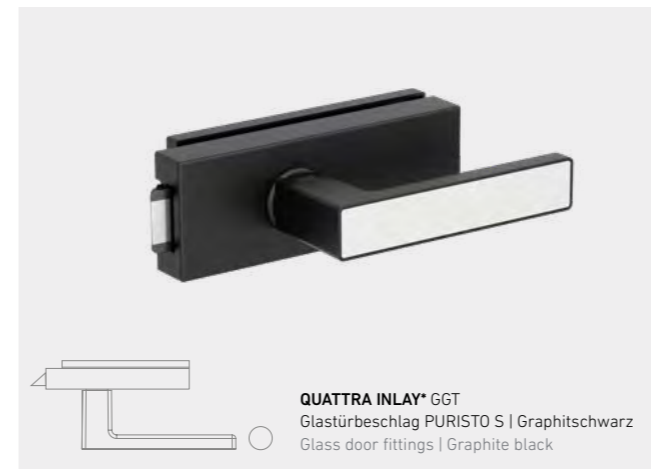
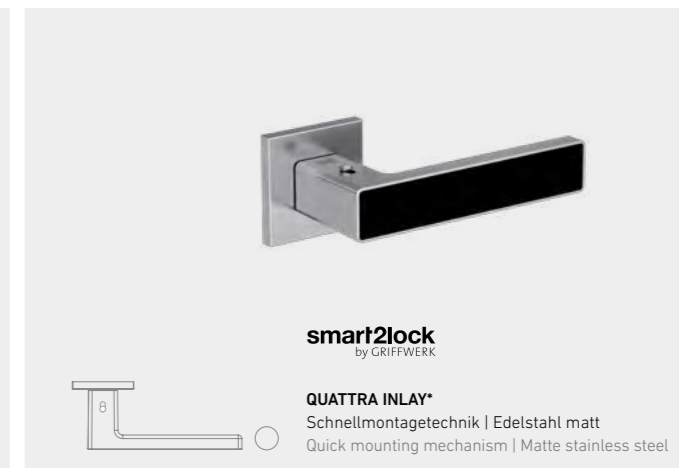
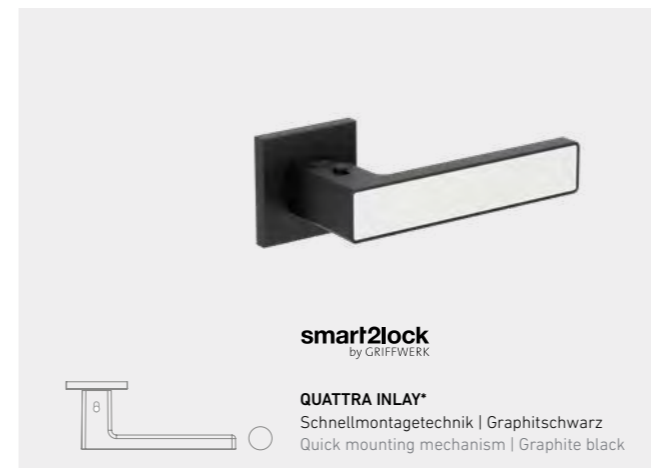
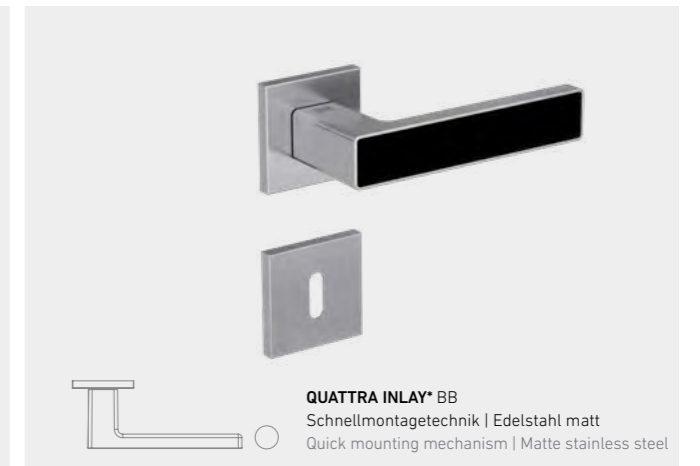
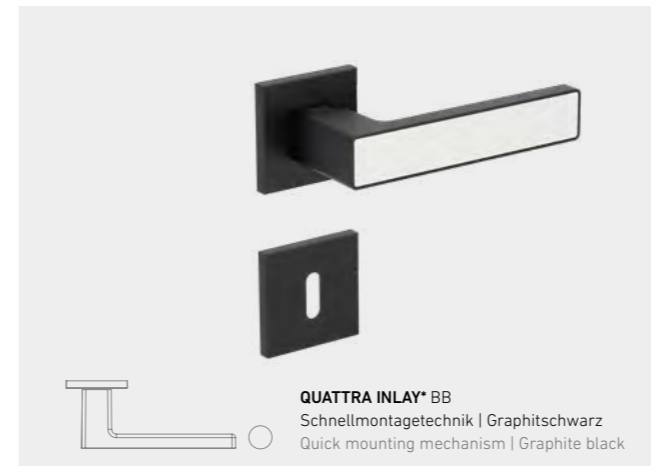
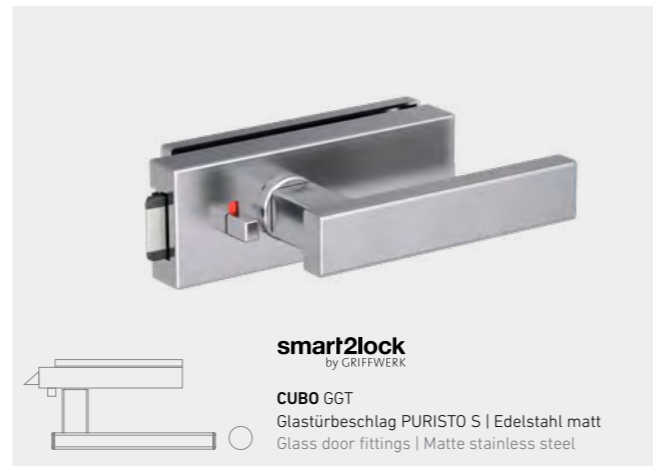
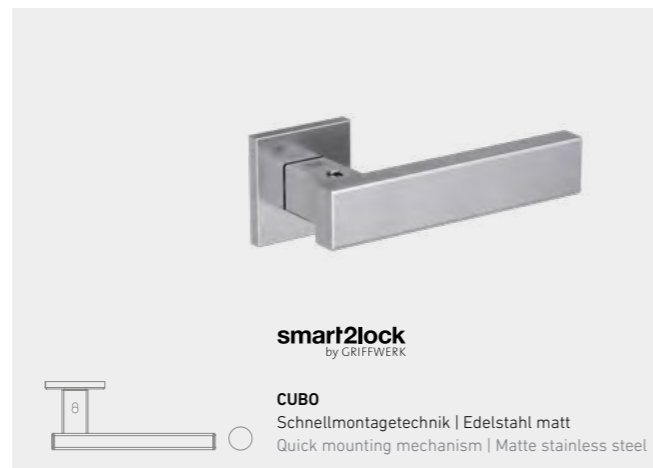
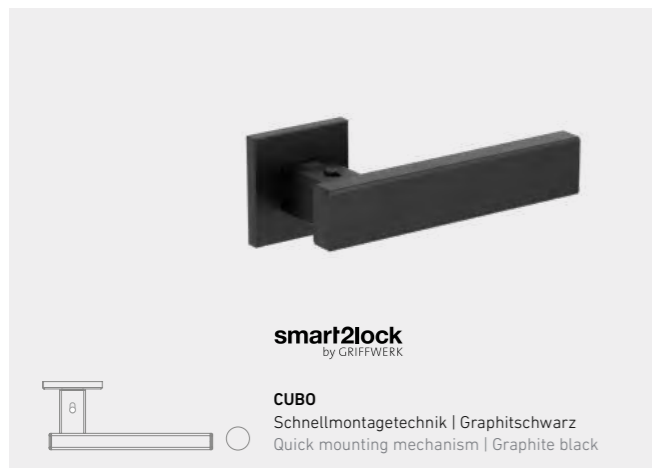
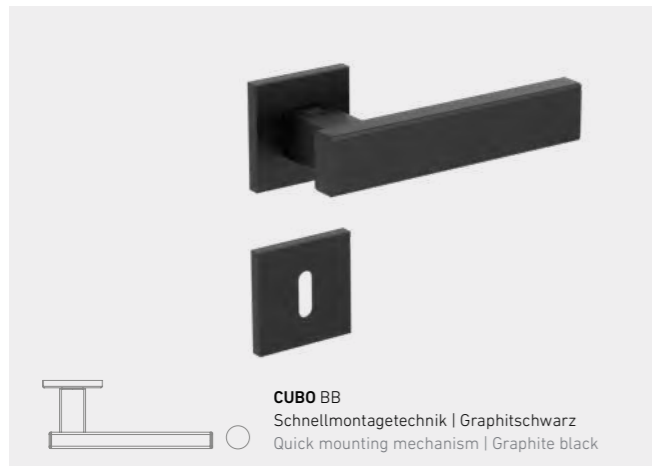

MONO

STANDARD-ROSETTE
STANDARD ROSETTE



BB-Schloss Rosette
BB lock with magnetic rosette



WC-Schloss
WC lock

PZ-Schloss
PZ lock



Schutzbeschlag EH, RD
EH, RD security lock plate

PZW-Knopf
PZW knob

BÄNDER SCHLÖSSER
HINGES LOCKS



2-teiliges Holztürenband
2-part wooden door hinge



3-teiliges Holztürenband
3-part wooden door hinge



BB/PZ Schloss
Schlossstulp
BB/PC lock
lock neck



Magnetschloß lang
Schlossstulp
Long magnetic lock
lock neck



Schließblech lang
Long locking plate

MONO

STANDARD
STANDARD



UV-Schloss
UV lock



PZ-Schloss
PZ lock



smart2lock
by GRIFFWERK

NOVO

STANDARD
STANDARD



UV-Schloss
UV lock



PZ-Schloss
PZ lock



smart2lock
by GRIFFWERK

NEO

STANDARD
STANDARD



UV-Schloss
UV lock



PZ-Schloss
PZ lock



smart2lock
by GRIFFWERK

CUBO

STANDARD
STANDARD



UV-Schloss
UV lock



PZ-Schloss
PZ lock



smart2lock
by GRIFFWERK

QUATTRA INLAY

STANDARD-ROSETTE
STANDARD ROSETTE



BB-Schloss Rosette
BB lock with magnetic rosette



WC-Schloss
WC lock

PZ-Schloss
PZ lock



Schutzbeschlag EH, RD
EH, RD security lock plate

PZW-Knopf
PZW knob

BÄNDER ZUBEHÖR
HINGES ACCESSORIES



Gegenkasten (2-flg.)
Strike box (2-part)



Band (3-tlg.)
Hinge (3-part)



Schließblech kurz
Short locking plate

MONO

STANDARD-ROSETTE
STANDARD ROSETTE



BB-Schloss Rosette
BB lock with magnetic rosette

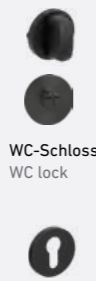

WC-Schloss
WC lock

PZ-Schloss
PZ lock



Schutzbeschlag EH, RD
EH, RD security lock plate

PZW-Knopf
PZW knob

BÄNDER SCHLÖSSER
HINGES LOCKS



2-teiliges Holztürenband
2-part wooden door hinge



3-teiliges Holztürenband
3-part wooden door hinge



BB/PC Schloss
Schloßstulp Schwarz
BB/PC lock
Graphite black lock neck



Magnetschloß lang
Schloßstulp Schwarz
Long magnetic lock
Graphite black lock neck



Schließblech lang
Long locking plate

MONO

STANDARD
STANDARD



UV-Schloss
UV lock



PZ-Schloss
PZ lock



smart2lock
by GRIFFWERK

NOVO

STANDARD
STANDARD



UV-Schloss
UV lock



PZ-Schloss
PZ lock



smart2lock
by GRIFFWERK

NEO

STANDARD
STANDARD



UV-Schloss
UV lock



PZ-Schloss
PZ lock



smart2lock
by GRIFFWERK

CUBO

STANDARD
STANDARD



UV-Schloss
UV lock



PZ-Schloss
PZ lock



smart2lock
by GRIFFWERK

QUATTRA INLAY

STANDARD-ROSETTE
STANDARD ROSETTE



BB-Schloss Rosette
BB lock with magnetic rosette



WC-Schloss
WC lock

PZ-Schloss
PZ lock



Schutzbeschlag EH, RD
EH, RD security lock plate

PZW-Knopf
PZW knob

BÄNDER ZUBEHÖR
HINGES ACCESSORIES



Gegenkasten (2-flg.)
Strike box (2-part)



Band (3-tlg.)
Hinge (3-part)



Schließblech kurz
Short locking plate

TOP

STYLE

PREMIUM

Besondere Akzente setzen

Make a big statement

DESIGNTÜRGRIFFE, DIE IN STIL UND HAPTİK ÜBERZEUGEN

Außergewöhnliches Design und mehr Komfort: Die Tür erfährt durch unsere Designtürgriffe eine zusätzliche Aufwertung. Zudem bieten die hochwertigen Oberflächen eine angenehme Haptik – ein Luxus, den sie täglich erleben können.

DESIGNER DOOR HANDLES WITH IMPRESSIVE STYLE AND HAPTICS

Exceptional design and extra convenience: Our designer door handles make the door look even more exclusive. Their premium finishes also enhance the haptics for luxury you can experience every day.



AVUS PIATTA S



**Griff
werk**



LUCIA PROFESSIONAL
Schraubtechnik | Graphitschwarz und Edelstahl matt
Rund- oder Quadratrossette
Screw mechanism | graphite black and matte stainless steel, round or square rosette



LUCIA PIATTA S
Flachrossette | Graphitschwarz und Edelstahl matt
Rund- oder Quadratrossette
Flat rosette | graphite black and matte stainless steel, round or square rosette



TRI 134
Schraubtechnik | Graphitschwarz und Edelstahl matt
Rund- oder Quadratrossette
Screw mechanism | graphite black and matte stainless steel, round or square rosette



TRI 134 PIATTA S
Flachrossette | Graphitschwarz und Edelstahl matt
Rundrossette
Flat rosette | graphite black and matte stainless steel, round or square rosette

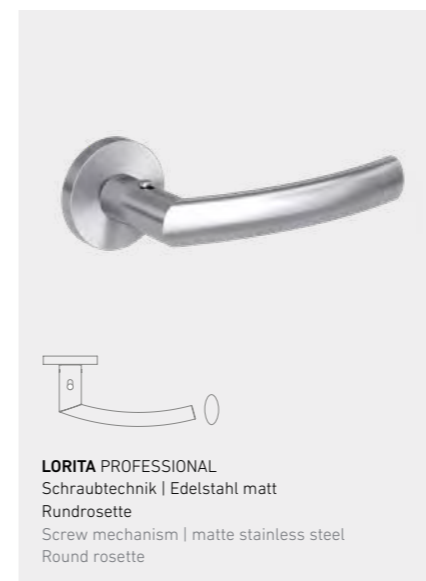

LORITA PROFESSIONAL
Schraubtechnik | Edelstahl matt
Rundrossette
Screw mechanism | matte stainless steel
Round rosette

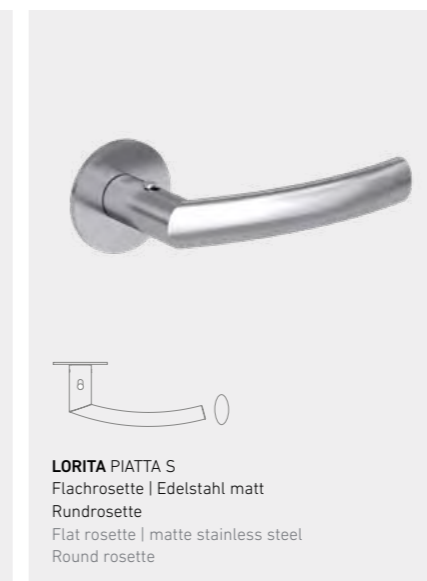

LORITA PIATTA S
Flachrossette | Edelstahl matt
Rundrossette
Flat rosette | matte stainless steel
Round rosette



AVUS PIATTA S
Flachrossette | Graphitschwarz und Kaschmirgrau,
Rundrossette
Flat rosette | graphite black and cashmere grey,
round rosette

Türgriffe der Extraklasse

Extra-special door handles

ONE – DESIGNKONZEPT OHNE ROSETTEN

Maximale Reduktion, dafür steht ONE: Auf Rosetten wird bei dieser Türgriffserie völlig verzichtet. Der Griff sitzt direkt auf dem Türblatt auf und passt dennoch auf Türen mit Standardschlössern. Bei der Version mit Schließmechanik wurde diese in den Griffhals integriert. Ein Griffdesign für höchste Ansprüche.

ONE – NO-ROSETTE DESIGN

ONE is all about minimalism: this range of door handles dispenses entirely with rosettes. The handle is positioned directly on the door and it is suitable for doors with standard locks. In the version with locking mechanism, the locking mechanism is located in the handle neck. A handle designed to meet highest expectations.

AVUS ONE



Griff
werk



AVUS ONE

Rosettenlos | Samtgrau, Graphitschwarz,
Kaschmirgrau, Gold
No rosette | velvet grey, graphite black,
cashmere grey, gold

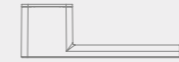

smart2lock by GRIFFWERK

AVUS ONE

Rosettenlos | Samtgrau, Graphitschwarz,
Kaschmirgrau, Gold
No rosette | velvet grey, graphite black,
cashmere grey, gold

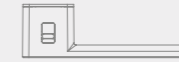

R8 ONE

Rosettenlos | Samtgrau, Graphitschwarz,
Kaschmirgrau
No rosette | matte stainless steel, graphite grey,
cashmere grey



smart2lock by GRIFFWERK

R8 ONE

Rosettenlos | Samtgrau, Graphitschwarz,
Kaschmirgrau
No rosette | matte stainless steel, graphite grey,
cashmere grey



SCHIEBETÜRGRIFFE FÜR HOLZ- UND GANZGLASTÜREN | EDELSTAHL MATT
 SLIDING DOOR HANDLES FOR WOODEN AND FULL GLASS DOORS | MATTE STAINLESS STEEL

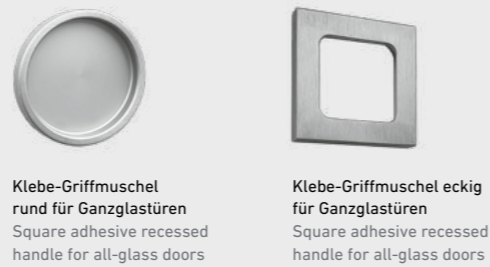
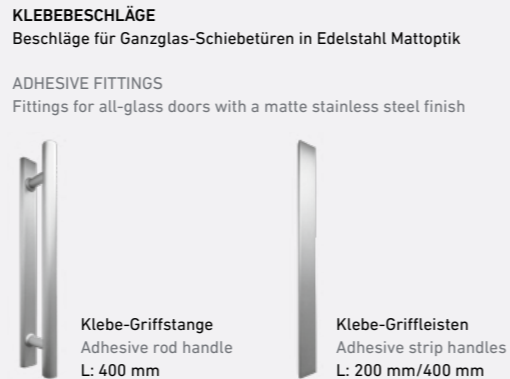

SCHIEBETÜRGRIFFE für Holz- und Ganzglastüren | Schwarz*
 SLIDING DOOR HANDLES FOR WOODEN AND FULL GLASS DOORS | BLACK*

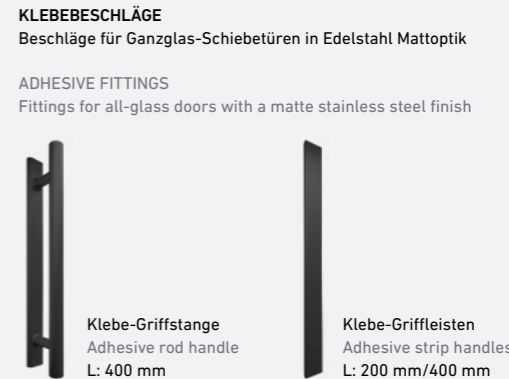
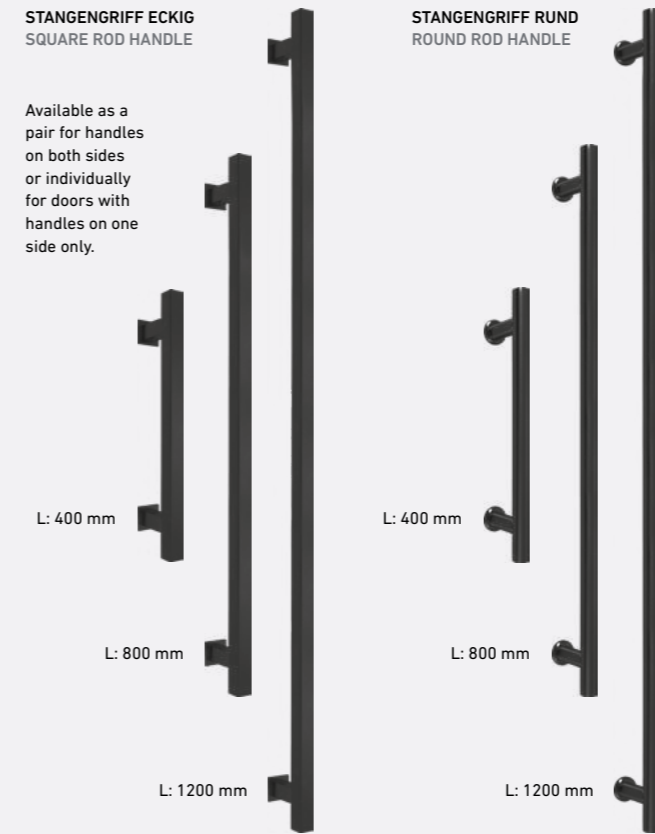

*ähnlich RAL9005 *like RAL9005

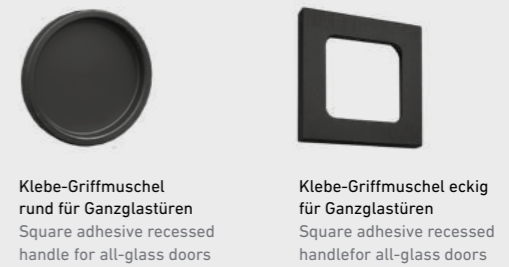

Kleine Rundkante an Türblättern und Zargen in Weißlack 9016

Small rounded edges on the door leaf and frames in white varnish 9016

GARANT Türen und Zargen in Weißlack 9016 sind mit einer kleinen Rundkante (KR) verfügbar.
GARANT doors and frames in white varnish 9016 are available with a small rounded edge (KR).

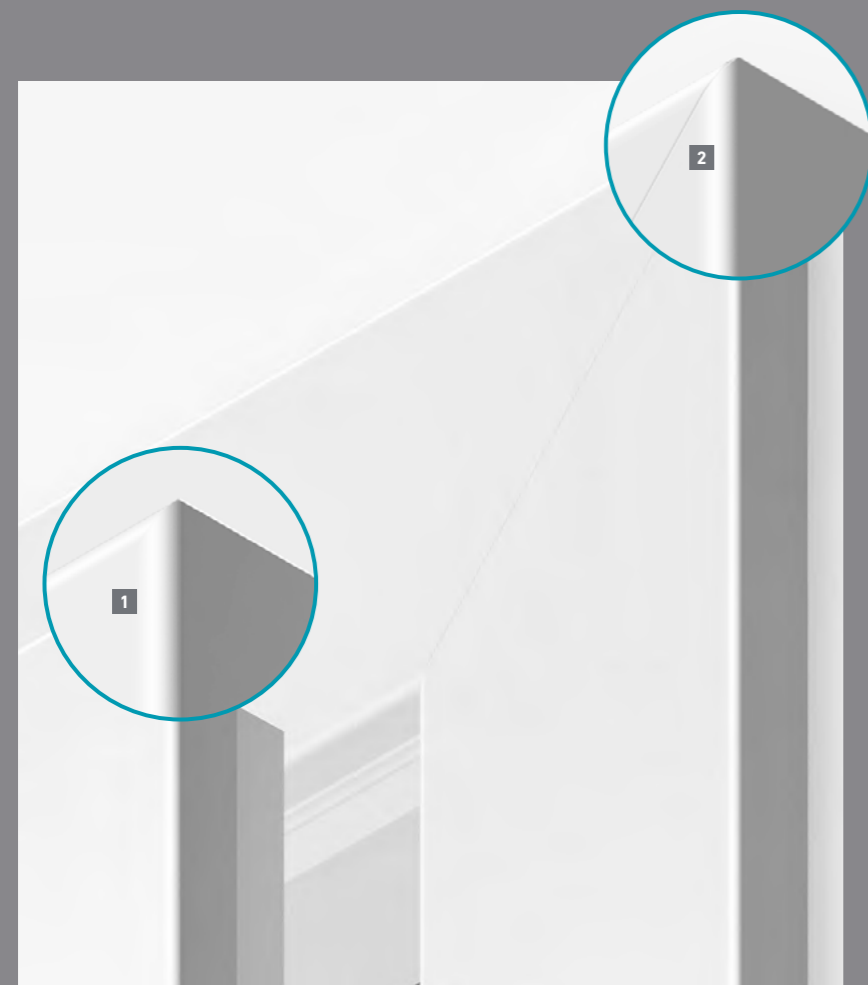

- 1** **NORMTÜR**
Kleine Rundkante
- 2** **NORMZARGE KR1**
Bekleidung kleine Rundkante (60 mm)
Futterplatte rund
- 1** **STANDARD DOOR**
Small rounded edge
- 2** **STANDARD FRAME KR1**
Casing with a small rounded edge (60 mm)
Rounded jamb

Breite Zargenbekleidungen machen den Unterschied

Les chambranles larges font la différence

Verbessern auch Sie die Optik Ihrer Türen durch breitere Zargen-Bekleidungen!
Améliorer également l'optique de vos portes à travers des chambranles plus larges!



QUERSCHNITT | CROSS SECTION

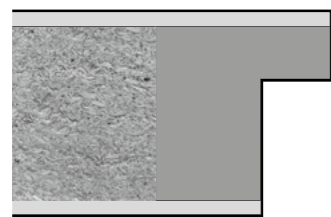

ECKIGE KANTE (E)
SQUARE EDGE (E)

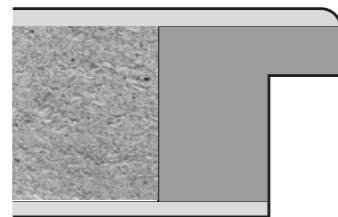

KLEINE RUNDKANTE (KR)
SMALL ROUNDED EDGE (KR)

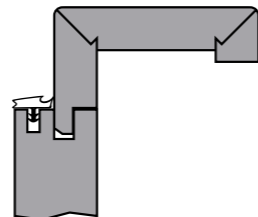

ZARGE MIT KLEINER RUNDKANTE,
60 MM BEKLEIDUNG
FRAME WITH SMALL ROUNDED EDGE,
60 MM CASING

ZARGE: 60 MM BEKLEIDUNG
FRAME: CASING 60 MM

-  WEISSLACK 9016
WHITE VARNISH 9016
-  WEISSLACK 9010
WHITE VARNISH 9010

ZARGE: 100 MM BEKLEIDUNG
FRAME: CASING 100 MM

-  WEISSLACK 9016
WHITE VARNISH 9016

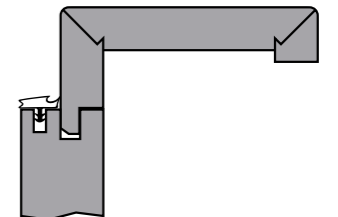

ZARGE MIT KLEINER RUNDKANTE,
100 MM BEKLEIDUNG
FRAME WITH SMALL ROUNDED EDGE,
100 MM CASING

Türkanten und Zargenausführungen im Überblick

Overview of door edges and frames



NORMTÜR
Runde Kante

NORMZARGE R1
Bekleidung rund
(60 und 75 mm)
Futterplatte rund

STANDARD DOOR
Rounded edge

STANDARD FRAME R1
Rounded casing
(60 and 75 mm)
Rounded jamb



NORMTÜR
Eckige Kante

NORMZARGE E1
Bekleidung eckig
(55 und 75 mm)
Futterplatte eckig

STANDARD DOOR
Square edge

STANDARD FRAME E1
Square casing
(55 and 75 mm)
Square jamb



NORMTÜR
Kleine Rundkante

NORMZARGE KR1
Bekleidung kleine Rundkante
(60 mm)
Futterplatte rund

STANDARD DOOR
Small rounded edge

STANDARD FRAME KR1
Casing with a small rounded edge
(60 mm)
Rounded jamb



NORMTÜR
Kleine Rundkante

NORMZARGE KR1
Bekleidung kleine Rundkante
(100 mm)
Futterplatte rund

STANDARD DOOR
Small rounded edge

STANDARD FRAME KR1
Casing with a small rounded edge
(100 mm)
Rounded jamb



WEISSLACK 9010
WHITE VARNISH 9010



WEISSLACK 9016
WHITE VARNISH 9016



WEISSLACK 9016
WHITE VARNISH 9016



WEISSLACK 9016
WHITE VARNISH 9016



NORMTÜR
Runde Kante

NORMZARGE P1
Bekleidung profiliert
(75 mm)
Futterplatte rund

STANDARD DOOR
Rounded edge

STANDARD FRAME P1
Profiled casing
(75 mm)
Profiled jamb



NORMTÜR STUMPF
Stumpfe Kante

NORMZARGE SE1
Bekleidung eckig
(55 mm)
Futterplatte eckig

STANDARD FLUSH-FITTED DOOR
Flush edge

STANDARD FRAME SE1
Square casing
(55 mm)
Square jamb



NORMTÜR STUMPF
Stumpfe Kante

NORMZARGE SR1
Bekleidung rund
(60 mm)
Futterplatte rund

STANDARD FLUSH-FITTED DOOR
Flush edge

STANDARD FRAME SR1
Rounded casing
(60 mm)
Rounded jamb



NORMTÜR STUMPF
Stumpfe Kante

NORMZARGE SKR1
Bekleidung kleine Rundkante
(60 mm)
Futterplatte rund

STANDARD FLUSH-FITTED DOOR
Flush edge

STANDARD FRAME SKR1
Casing with a small rounded edge
(60 mm)
Rounded jamb



WEISSLACK 9010
WHITE VARNISH 9010



WEISSLACK 9016
WHITE VARNISH 9016



WEISSLACK 9010
WHITE VARNISH 9010

Ausführungen gefälzt und stumpf

Rebated and flush versions



Gefälzte Türansicht
View of a rebated door

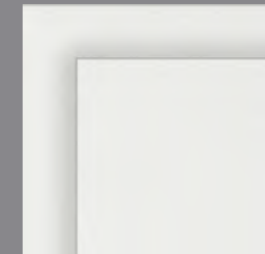

Detailansicht
Detailed view



2-tlg. Band
(gefälzte Türen)
2-part hinge
(rebated door)

3-tlg. Band
(gefälzte Türen)
2-part hinge
(rebated door)



Stumpfe Türansicht
View of a flush-fitted door

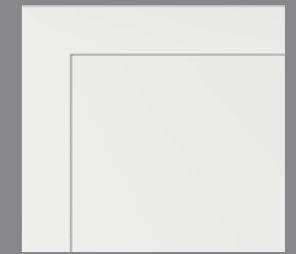

Detailansicht
Detailed view



Verdeckte Bänder
bei stumpfen Türen
Concealed hinges
(flush-fitted doors)

Blockrahmen und Blendrahmen

Block frames and blind frames

Aufbau Blockrahmen
Block frame construction

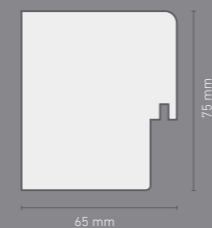

Wandprofil
Wall edge

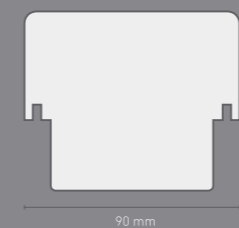

Kämpfer / Pfosten
Traverse / Pole

Aufbau Blendrahmen
Blind frame construction

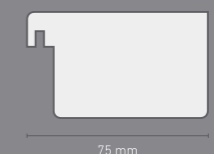

Wandprofil
Wall edge

Sieht gut aus. Fühlt sich gut an. Looks good. Feels good.

Unsere hochwertig Weißlackoberflächen
Our premium white varnished finishes

WEISSLACK-EIGENSCHAFTEN

Unsere Weißlackoberfläche ähnelt dem RAL-Farbtönen 9016 oder 9010. Ein umweltfreundliches Walzlackierverfahren ermöglicht optimalen Grundier- und Lackauftrag. Nach einer Hydro-Grundierung erfolgt ein mehrfacher Acryllackauftrag, der UV-gehärtet wird.

Bei profilierten Oberflächen kommt eine Kombination aus Walzverfahren und Spritzverfahren zum Einsatz. Hierbei werden die Profile manuell im Spritzverfahren grundiert. Anschließend werden im Walzverfahren die glatten Flächen mit Hydro-Grundierung versehen. Als Letztes erfolgt ein mehrfacher Acryllackauftrag mittels Spritzroboter, der mit einer UV-Härtung abgeschlossen wird. Das Ergebnis ist eine griffsympathische, seidenmatte Weißlackoberfläche.

WHITE VARNISH PROPERTIES

Our white varnish finish is similar in colour to RAL 9016 or 9010. An eco-friendly roller coating process ensures the optimum application of the primer and varnish. The hydro primer is followed by several layers of UV-hardened acrylic varnish.

A combination of roller and spray coating is used for profiled finishes. The profiles are primed manually by spray coating. Then the smooth surfaces are primed with hydro primer in a roller coating process. The final stage in the process is the application of multiple layers of acrylic varnish by spraying robots and UV hardening. The result is a pleasant-to-touch, silk-matte, white varnish finish.



Weißlack mit Funktion Functional white varnish

Alle Türen mit Weißlack-Oberflächen können auch als Funktionstür ausgestattet werden. Hier steht die volle Bandbreite von Türen mit Barrierefreiheit über einbruchssichere Türen, Türen mit Schall- und Wärmeschutz bis zur Brandschutztür zur Auswahl.

All doors with white varnish finishes can be functional doors. There are a wide range of options in this respect, from accessibility doors to anti-burglary doors, doors with heat and noise insulation and fire doors.

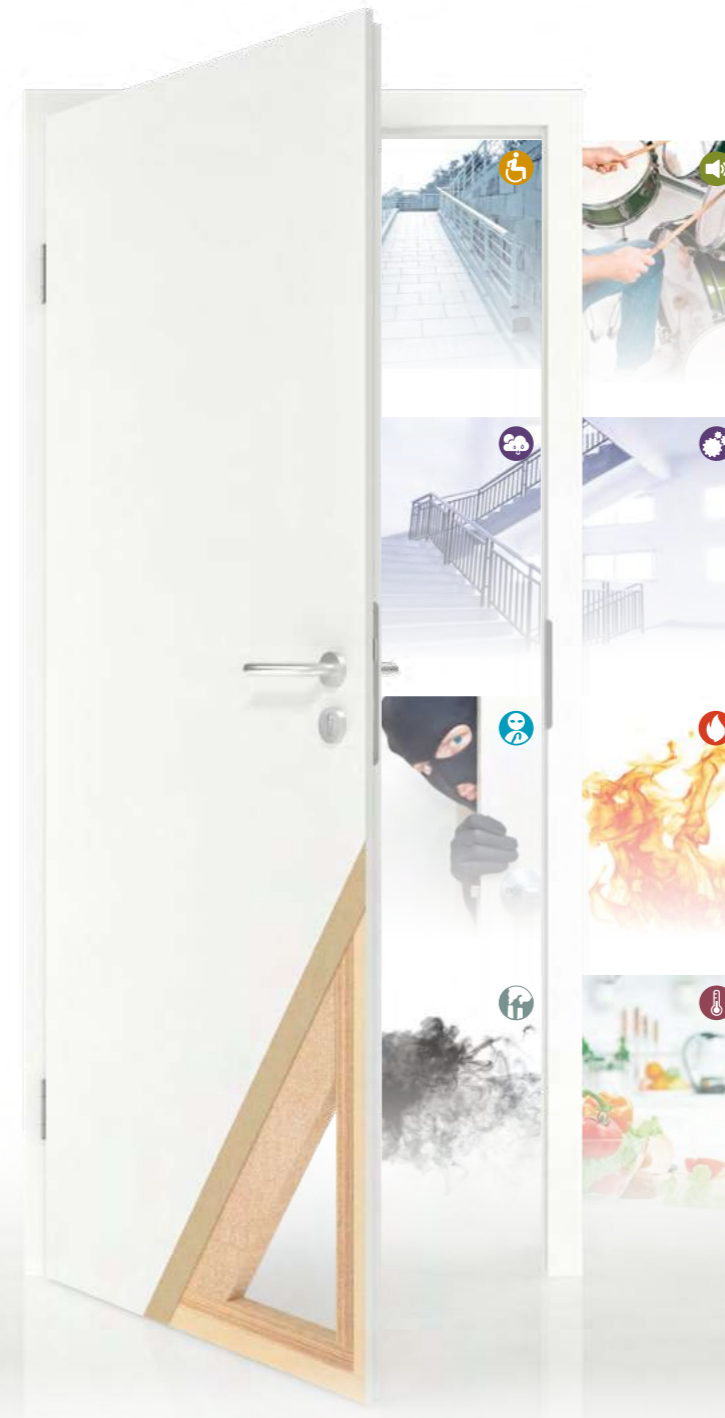

BARRIEREFREIHEIT
ACCESSIBILITY



KLIMASTABILITÄT
CLIMATE STABILITY



MECHANISCHE BEANSPRUCHUNG
MECHANICAL STRESS



SCHALLSCHUTZ
NOISE INSULATION



EINBRUCHSCHUTZ
ANTI-BURGLARY



FEUERSCHUTZ
FIRE PROTECTION



RAUCHSCHUTZ
SMOKE PROTECTION



WÄRMEDÄMMSCHUTZ
HEAT INSULATION

Weißlack mit Funktion

White varnish functional doors

Unsere Funktionstüren schützen Sie und Ihre privaten oder geschäftlichen Räume und Güter vor den unterschiedlichsten negativen Einflüssen wie Schall, Einbruch, Feuer und Rauch.

Our functional doors protect you, your home and your business premises and assets from the diverse negative effects of noise, burglary, fire and smoke.



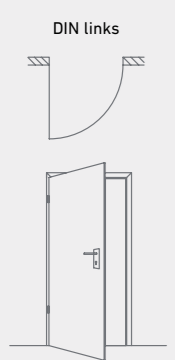
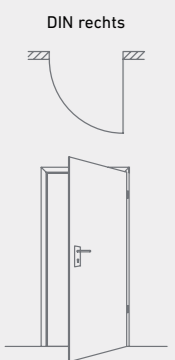

TÜRBLATTGRÖSSEN (VORZUGSGRÖSSEN NACH DIN 18101)											
EINFLÜGELIGE TÜREN						ZWEIFLÜGELIGE TÜREN					
Wandöffnungsmaß		Türblatt-Außenmaße				Wandöffnungsmaß		Türblatt-Außenmaße			
		Gefälztes Türblatt		Ungefälztes Türblatt				Gefälztes Türblatt		Ungefälztes Türblatt	
Breite (b1)	Höhe (h1)	Breite (b5)	Höhe (h5)	Breite (b5)	Höhe (h5)	Breite (b1)	Höhe (h1)	Breite (b5)	Höhe (h5)	Breite (b5)	Höhe (h5)
635	2005	610	1985	584	1972	1260	2005	1210	1985	1184	1972
760	2005	735	1985	709	1972	1510	2005	1460	1985	1434	1972
885	2005	860	1985	834	1972	1760	2005	1710	1985	1684	1972
1010	2005	985	1985	959	1972	2010	2005	1960	1985	1934	1972
1135	2005	1110	1985	1084	1972	2350	2005	2210	1985	2184	1972
1260	2005	1235	1985	1209	1972	2600	2005	2460	1985	2434	1972
635	2130	610	2110	584	2097	1260	2130	1210	2110	1184	2097
760	2130	735	2110	709	2097	1510	2130	1460	2110	1434	2097
885	2130	860	2110	834	2097	1760	2130	1710	2110	1684	2097
1010	2130	985	2110	959	2097	2010	2130	1960	2110	1934	2097
1135	2130	1110	2110	1084	2097	2350	2130	2210	2110	2184	2097
1260	2130	1235	2110	1209	2097	2600	2130	2460	2110	2434	2097

1. Normalhöhe nach DIN 18100 (Nennmaß) (h1)	2005				2130									
Maueröffnungshöhe min.-max. in [mm] (h1)	2000-2015*				2125-2140*									
Türblattaußenmaße in [mm] (h5)	1985				2110									
2. Normalbreite (1 flg.) nach DIN 18100 (Nennmaß) (b1)	635		885		1010		1260							
Maueröffnungsbreite min.-max. in [mm] (b1)	625-645*		875-895*		1000-1020*		1250-1270*							
Türblattaußenmaße in [mm] (b5)	610		860		985		1235							
3. Normalbreite (2 flg.) nach DIN 18100 (Nennmaß)	1260		1510		1760		2010							
Maueröffnungsbreite min.-max. in [mm]	1250-1270*		1500-1520*		1750-1770*		2000-2020*							
Türblattaußenmaße in [mm]	1210		1460		1710		1960							
* Bei Einsatz einer Holzumfassungszarge empfiehlt GARANT das Maximalmaß.														
4. Verstellbarkeit in [mm]	80-100	100-120	120-140	140-160	160-180	180-200	200-220	215-235	235-255	255-275	265-285	285-305	305-320	320-340
Futterbreite/Wanddicke	85	105	125	145	165	185	205	220	240	260	270	290	310	325

ZUBEHÖR

SCHLÖSSER

DICHTUNG



MODELL: BUNTBART-SCHLOSS



MODELL: PROFILZYLINDER-SCHLOSS



MODELL: SCHLOSS FÜR BADTÜREN



MODELL: ABSENKBARE BODENDICHTUNG

BÄNDER



MODELL: BANDKOMBINATION V 3420 WF FÜR HOLZZARGE



MODELL: BANDKOMBINATION V 4426 WF FÜR HOLZZARGE



MODELL: BANDKOMBINATION V 8026 WF FÜR STAHLZARGE

DOOR LEAF SIZES (STANDARD SIZES AS PER DIN 18101)											
SINGLE-LEAF DOORS						DOUBLE-LEAF DOORS					
Wall aperture measurements		Door leaf external measurements				Wall aperture measurements		Door leaf external measurements			
		Rebated door leaf		Flush door leaf				Rebated door leaf		Flush door leaf	
Length (b1)	Height (h1)	Length (b5)	Height (h5)	Length (b5)	Height (h5)	Length (b1)	Height (h1)	Length (b5)	Height (h5)	Length (b5)	Height (h5)
635	2005	610	1985	584	1972	1260	2005	1210	1985	1184	1972
760	2005	735	1985	709	1972	1510	2005	1460	1985	1434	1972
885	2005	860	1985	834	1972	1760	2005	1710	1985	1684	1972
1010	2005	985	1985	959	1972	2010	2005	1960	1985	1934	1972
1135	2005	1110	1985	1084	1972	2350	2005	2210	1985	2184	1972
1260	2005	1235	1985	1209	1972	2600	2005	2460	1985	2434	1972
635	2130	610	2110	584	2097	1260	2130	1210	2110	1184	2097
760	2130	735	2110	709	2097	1510	2130	1460	2110	1434	2097
885	2130	860	2110	834	2097	1760	2130	1710	2110	1684	2097
1010	2130	985	2110	959	2097	2010	2130	1960	2110	1934	2097
1135	2130	1110	2110	1084	2097	2350	2130	2210	2110	2184	2097
1260	2130	1235	2110	1209	2097	2600	2130	2460	2110	2434	2097

1. Standard height as per DIN 18100 (nominal height) (h1)	2005				2130									
Wall aperture height min.-max. in [mm] (h1)	2000-2015*				2125-2140*									
Door leaf external measurements [mm] (h5)	1985				2110									
2. Standard height (single leaf) as per DIN 18100 (nominal height) (b1)	635		885		1010		1260							
Wall aperture width min.-max. in [mm] (b1)	625-645*		875-895*		1000-1020*		1250-1270*							
Door leaf external measurements [mm] (b5)	610		860		985		1235							
3. Standard height (double leaf) as per DIN 18100 (nominal height) (b1)	1260		1510		1760		2010							
Wall aperture width min.-max. in [mm]	1250-1270*		1500-1520*		1750-1770*		2000-2020*							
Door leaf external measurements [mm]	1210		1460		1710		1960							
* GARANT recommends the maximum size if a closed wooden frame is being used.														
4. Adjustability in [mm]	80-100	100-120	120-140	140-160	160-180	180-200	200-220	215-235	235-255	255-275	265-285	285-305	305-320	320-340
Jamb width/ wall thickness	85	105	125	145	165	185	205	220	240	260	270	290	310	325

ACCESSORIES

LOCKS

SEALS



MODEL: WARDDED KEY LOCK



MODEL: PROFILE CYLINDER LOCK



MODEL: BATHROOM DOOR LOCK



MODEL: LOWERABLE BOTTOM SEAL

HINGES



MODEL: HINGE COMBINATION V 3420 WF FOR WOODEN FRAMES



MODEL: HINGE COMBINATION V 4426 WF FOR WOODEN FRAMES



MODEL: HINGE COMBINATION V 8026 WF FOR STEEL FRAMES

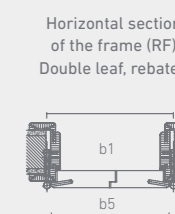
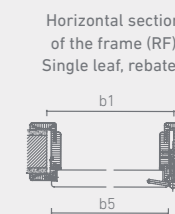
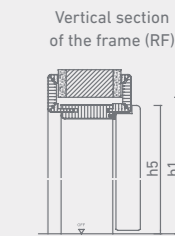
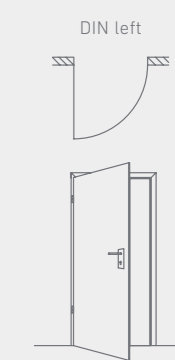
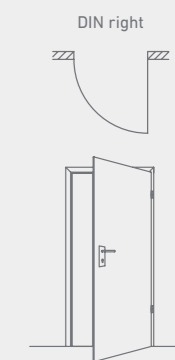

NORMTÜREN
STANDARD DOOR

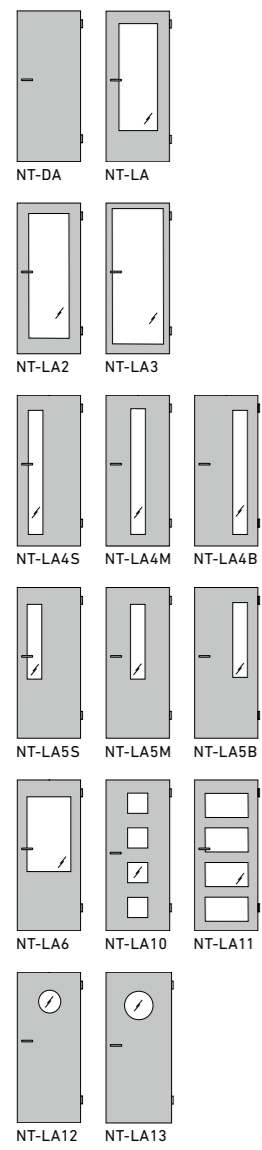

AMRUM
AMRUM

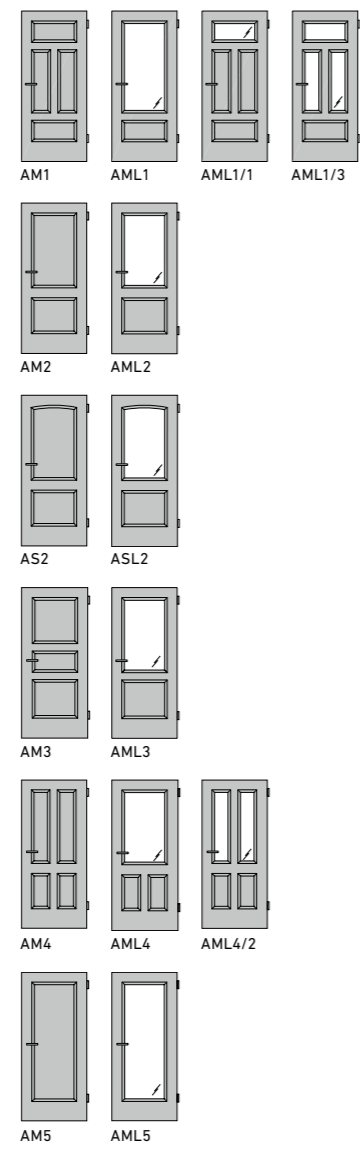

AURA
AURA

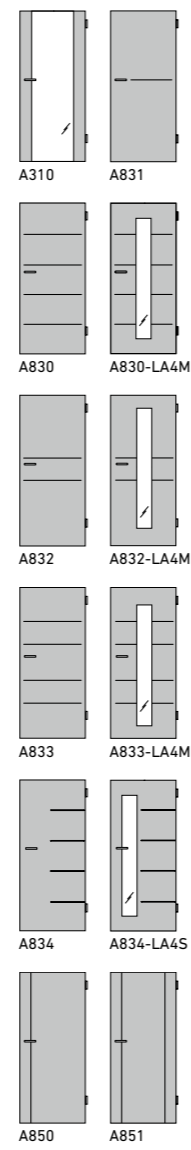

MILANO
MILANO

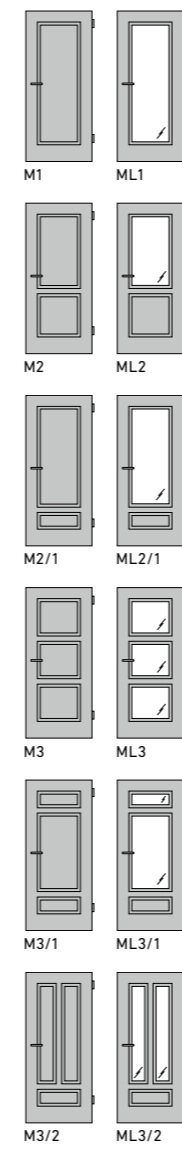

RIVA
RIVA

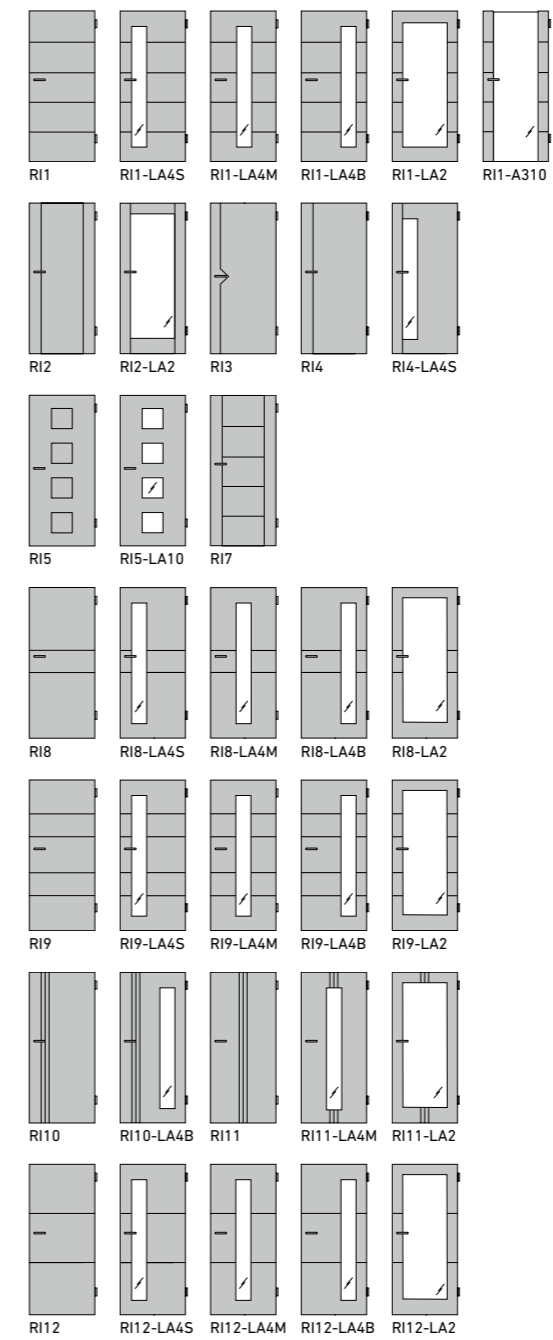

COMO
COMO

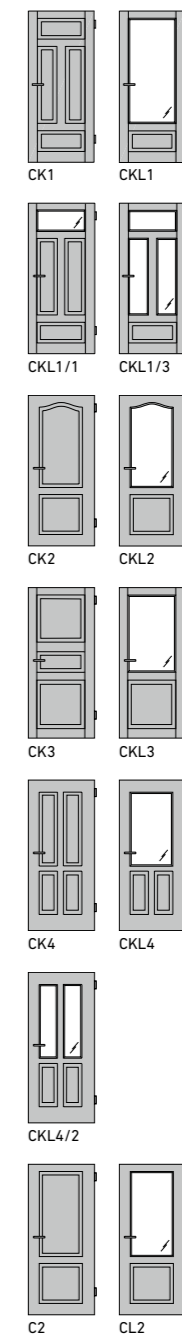

PARMA
PARMA

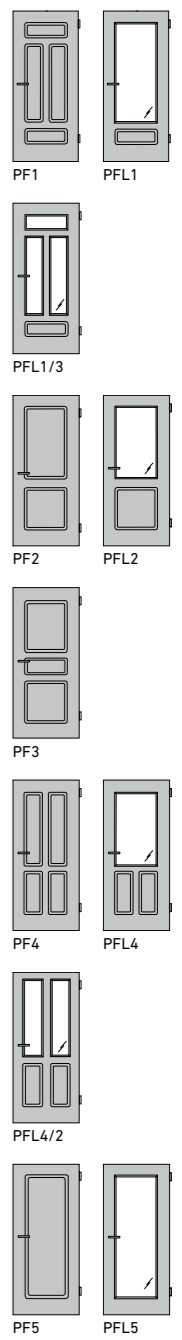

OBERFLÄCHEN | FINISHES



WEISSLACK 9016,
WEISSLACK 9010



WEISSLACK 9016,
WEISSLACK 9010

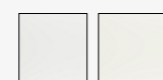

WEISSLACK 9016,
WEISSLACK 9010



WEISSLACK 9016,
WEISSLACK 9010



WEISSLACK 9016,
WEISSLACK 9010

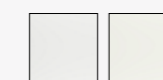

WEISSLACK 9016,
WEISSLACK 9010



WEISSLACK 9016,
WEISSLACK 9010

GANZGLASTÜREN DESIGN
ALL-GLASS DESIGN DOORS

LASER-VEREDELUNG | LASER DÉCOR

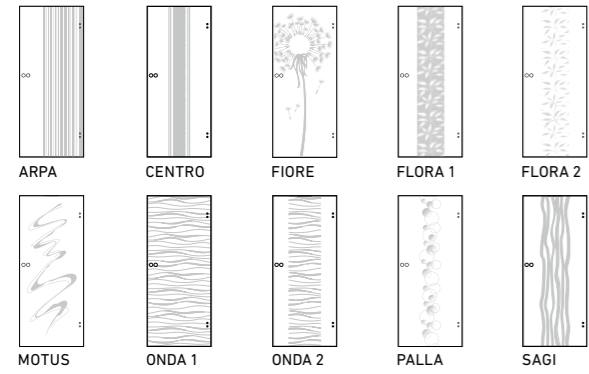

SIEBDRUCK-VEREDELUNG | SCREEN PRINTED DÉCOR

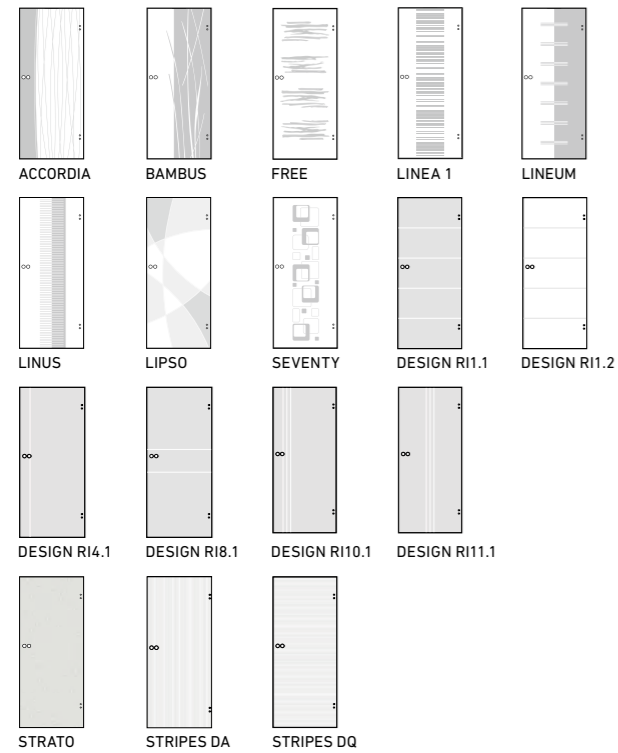

GANZGLASTÜREN ORNAMENT (NORM)
PATTERNED ALL-GLASS DOORS (STANDARD)

STANDARD-ORNAMENTGLAS | STANDARD PATTERNED GLASS

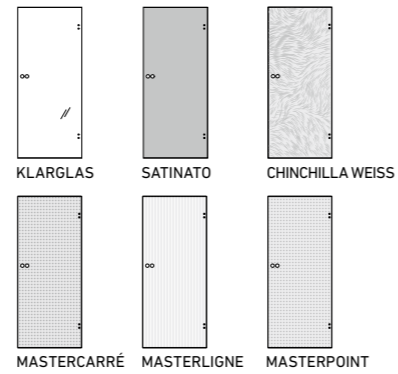

DESIGN-ORNAMENTGLAS | DESIGN PATTERNED GLASS

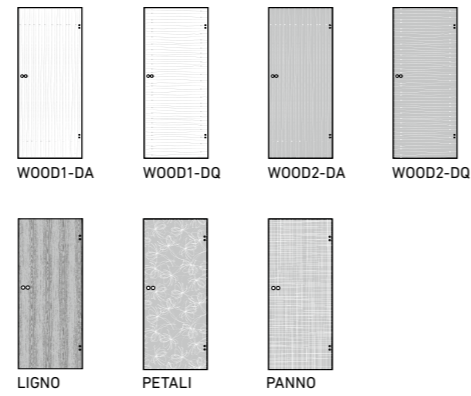

LICHTAUSSCHNITTGLÄSER
GLASS PANELS

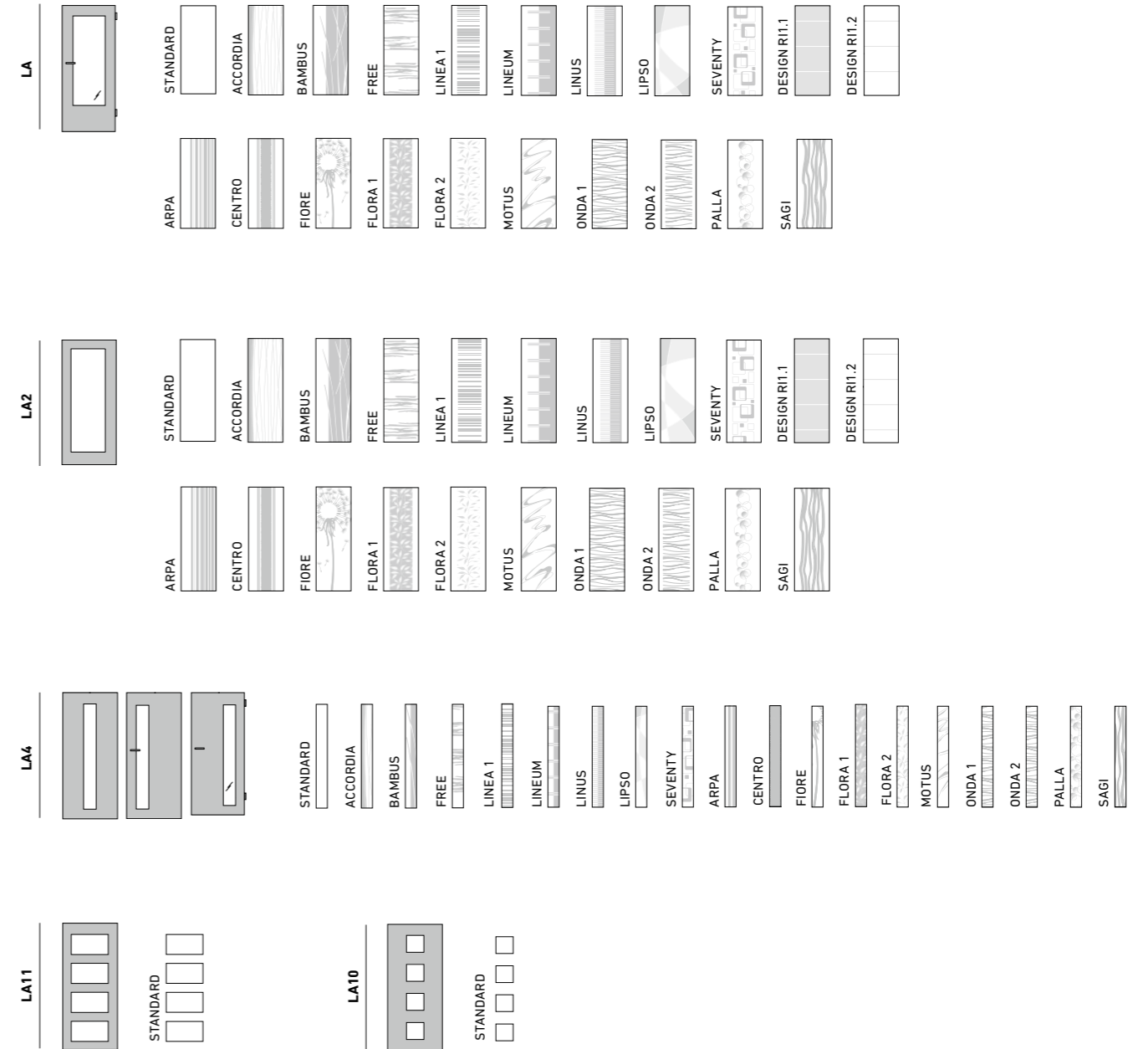

GLASBEISPIELE
EXAMPLES OF GLASS



STANDARD-LICHTAUSSCHNITTGLÄSER ALS ORNAMENTGLAS
STANDARD PATTERNED GLASS PANELS

- STANDARD-ORNAMENTGLÄSER**
- KLARGLAS
 - SATINATO
 - MASTERCARRÉ
 - MASTERLIGNE
 - MASTERPOINT
 - CHINCHILLA WEISS

- DESIGN-ORNAMENTGLÄSER**
- LIGNO
 - PETALI
 - PANNO
 - WOOD1-DA
 - WOOD1-DQ
 - WOOD2-DA
 - WOOD2-DQ

SPROSSENRAHMEN
MUNTIN FRAMES

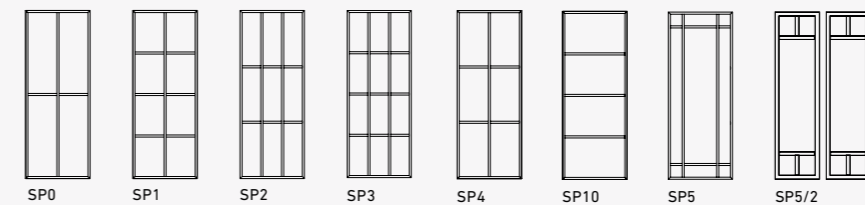

GARANT Türen und Zargen GmbH

OT Icktershausen
Garantstraße 1, Gewerbepark Thörey
99334 Amt Wachsenburg

T +49 (0) 36202/91-0
F +49 (0) 36202/91-150
E service@garant.de
I www.garant.de

Ein Unternehmen der Arbonia Doors

ARBONIA 
Doors

Ihr GARANT-Fachhändler:



 **GARANT**
Türen für mein Zuhause

Stand 05/2023

Drucktechnisch bedingte Farbabweichungen
sowie Änderungen am Produkt vorbehalten.

Gestaltung: Zentral-Marketing GARANT

Nur die mit FSC® gekennzeichneten Produkte sind zertifiziert.*

